

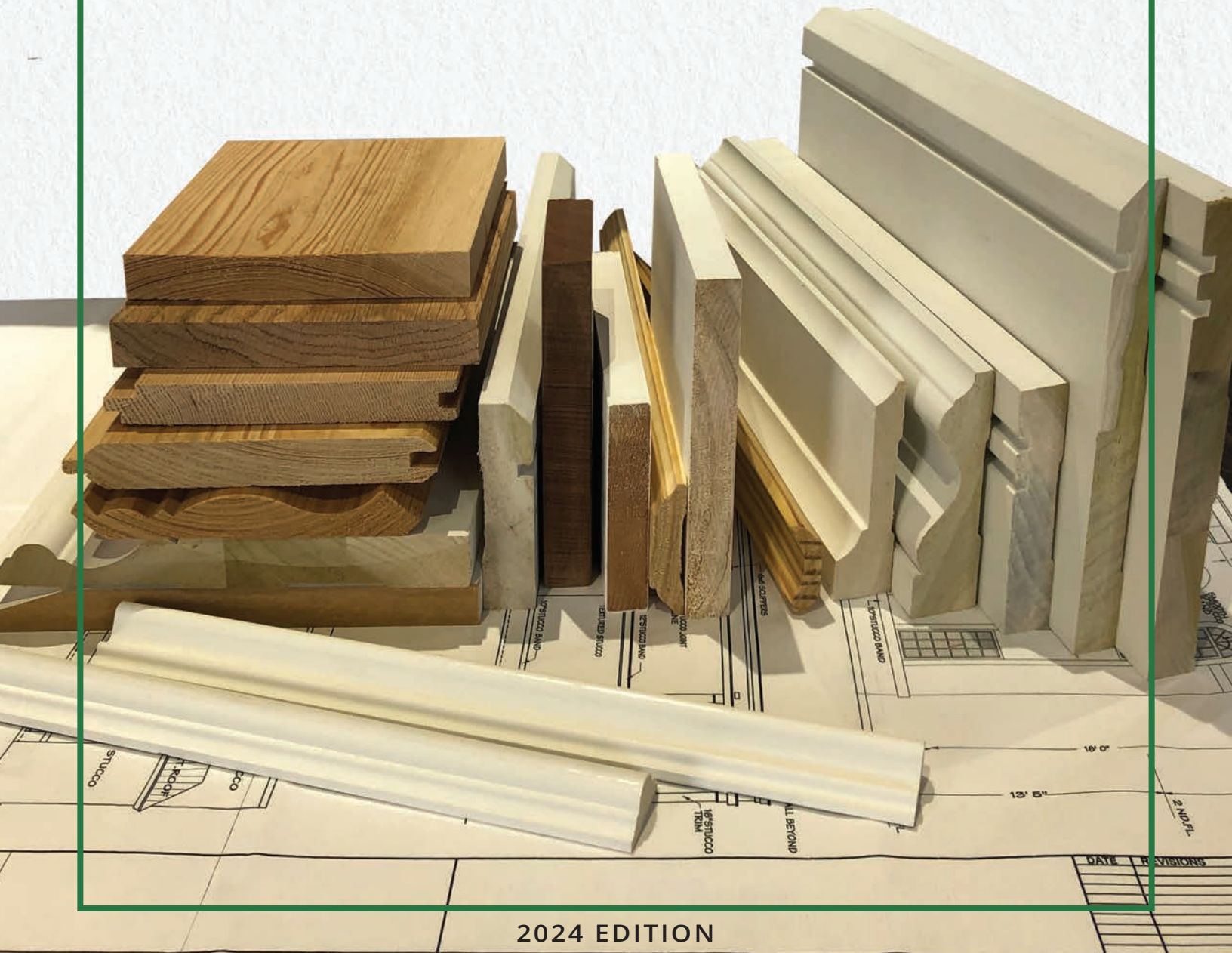

SMITH & EST. 1957
DESHIELDS
DOORS • MILLWORK • HARDWARE

IN-STOCK MOULDINGS



2024 EDITION

TABLE OF CONTENTS

03

STOCK BASEBOARDS

- Primed LDF
- Primed FJ Poplar
- Unprimed Solid Poplar
- Primed FJ WP

16

STOCK CASINGS

- Primed LDF
- Primed FJ Poplar
- Unprimed Solid Poplar
- Primed FJ WP

26

STOCK CROWNS

- Primed LDF
- Primed FJ Poplar
- Unprimed Solid Poplar
- Primed FJ WP
- Cypress
- Hard Maple

43

STOCK CHAIR RAILS

- Primed LDF Chair Rail/Misc.
- Primed FJ Poplar
- Unprimed Solid Poplar
- Primed FJ WP

48

STOCK S-4-S SURFACED 4 SIDES FLAT STOCK

- Primed LDF
- Primed FJ Poplar
- Unprimed Solid Poplar
- Primed FJ WP
- Red Oak
- Hard Maple
- Sapele Mahogany
- Select Cypress
- PVC

61

STOCK T&G MISC.

V-JOINT

- Primed LDF
- Primed FJ WP
- Select Cypress
- #2 Cypress

T&G NICKEL GAP

- Primed LDF
- Primed FJ WP
- Select Cypress
- C & Btr Fir

WINDOW STOOL

- Primed FJ Poplar

WINDOW EXT.

- Primed LDF

SHEET GOODS

- AC Plywood
- Birch Plywood
- MDF
- White Maple
- Bending Plywood
- Pine Face Bead Board

BRICK MOULDING

- Primed FJ WP
- PVC
- Sapele Mahogany

DOOR STOP

- Primed FJ Poplar
- Unprimed Solid Poplar
- Primed FJ WP
- Shoe Mid, Cove, Qtr. Round

T-ASTRAGAL

- Primed FJ Poplar
- PVC Exterior

BASE CAP

- Primed FJ Poplar
- Primed FJ WP Base Cap

PANEL MOULDING

- Primed FJ Poplar

ROPE MOULDING

- Poplar

APPLIED MOULDING

- Primed FJ Poplar
- Solid Clear WP
- Plinth & Rosettes
- Decra Moulding

STYLES

- Contemporary
- Combinations

STORAGE & HANDLING & FINISHING

83

LDF DOORS

- Plantation Series
- Cross Section
- Custom Entry Doors

Stock Baseboards

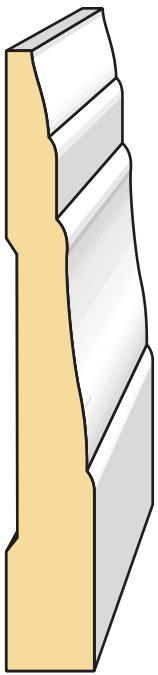

LDF 366B
1/2" x 3-1/4"

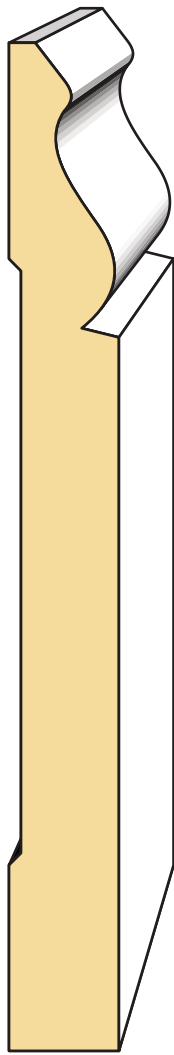

LDF 218B
9/16" x 5-1/4"

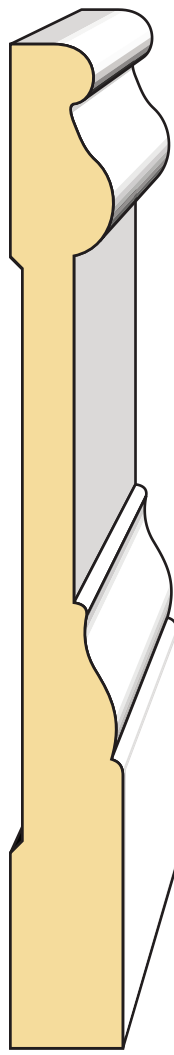

LDF VB
9/16" x 5-1/4"

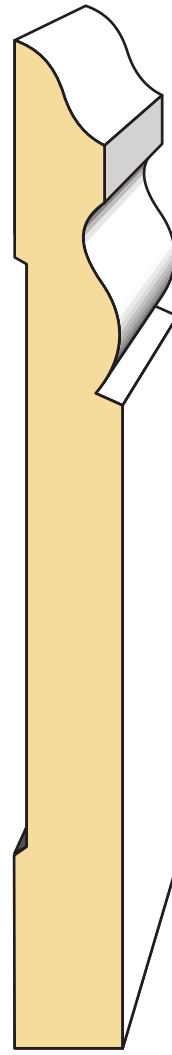

LDF 5180
9/16" x 5-1/4"

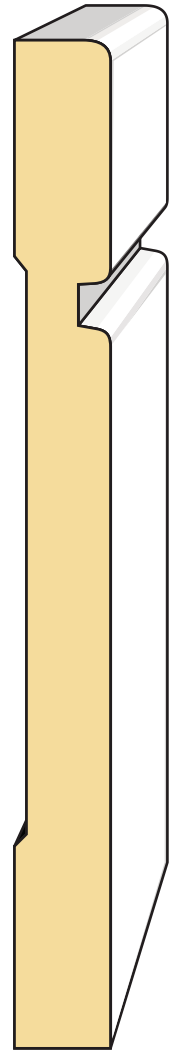

LDF BA514C
1/2" x 5-1/4"

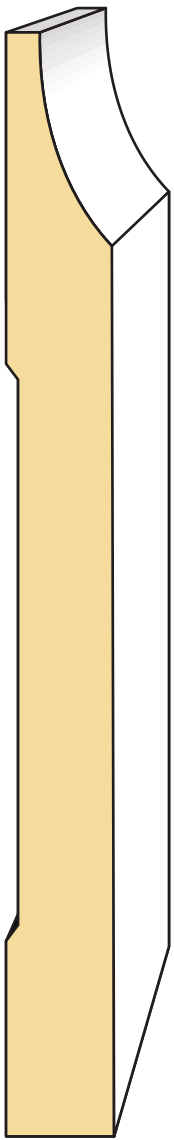

LDF BA534
9/16" x 5-3/4"

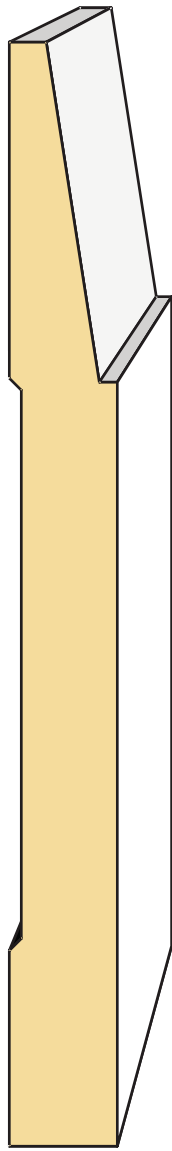

LDF BA534A
9/16" x 5-3/4"

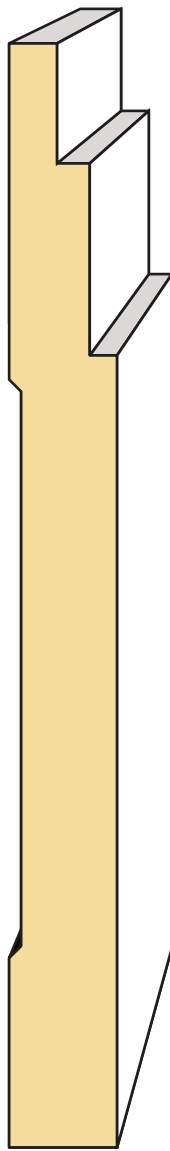

LDF BA534B
9/16" x 5-3/4"

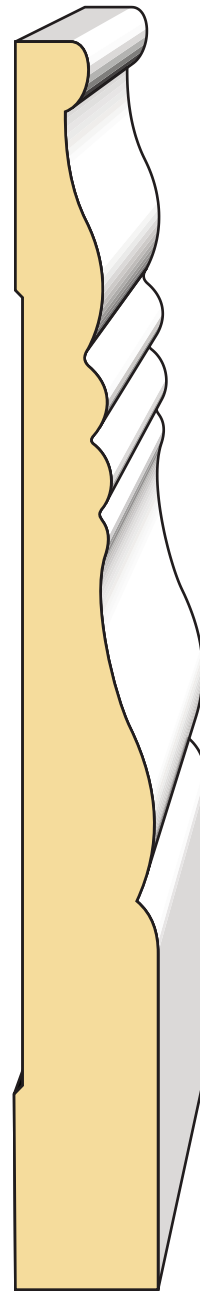

LDF 019
3/4" x 6-1/2"

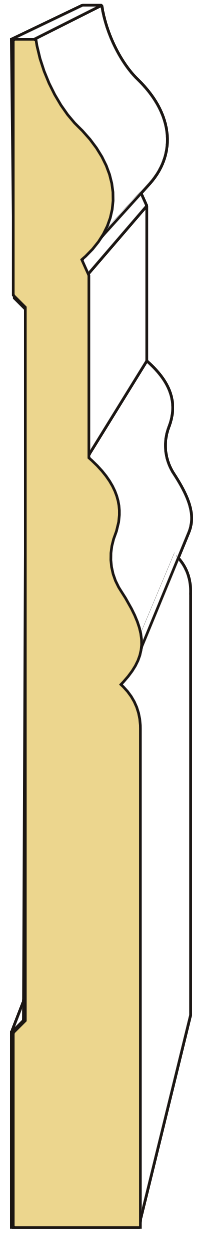

LDF VB6
11/16" x 6-14"

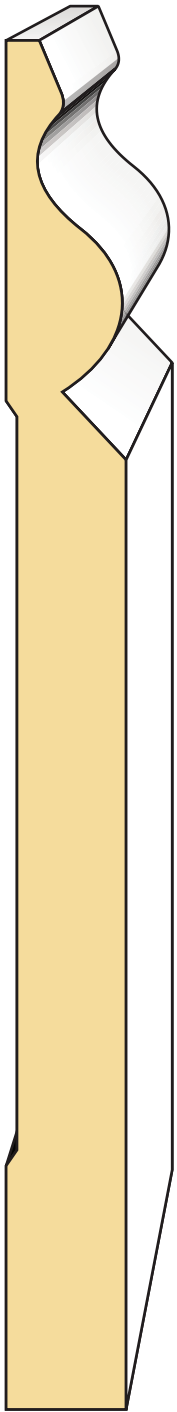

LDF BA718
5/8" x 7-1/8"

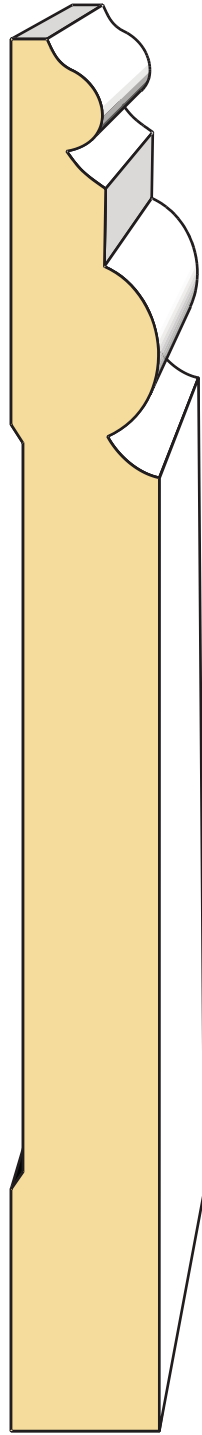

LDF BA714
3/4" x 7-1/4"

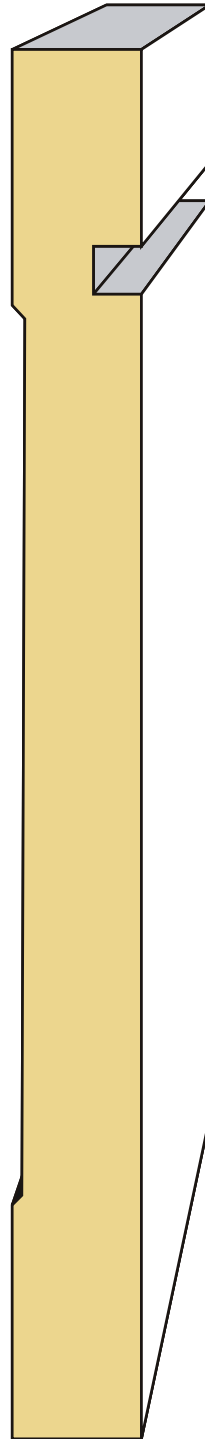

LDF BA714N
11/16" x 7-1/4"

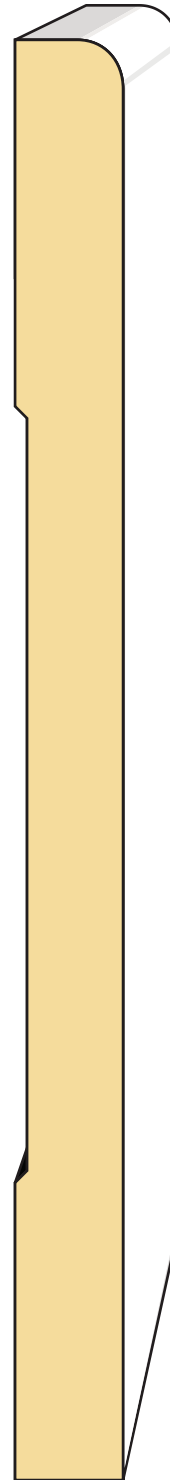

LDF BA712
9/16" x 7-1/2"

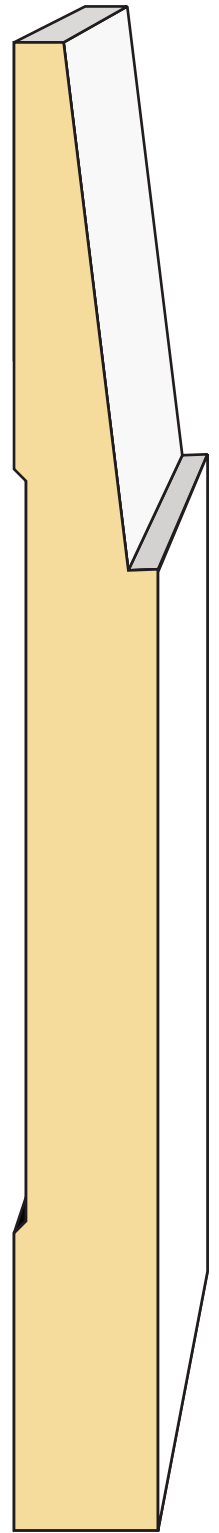

LDF BA734
3/4" x 7-3/4"

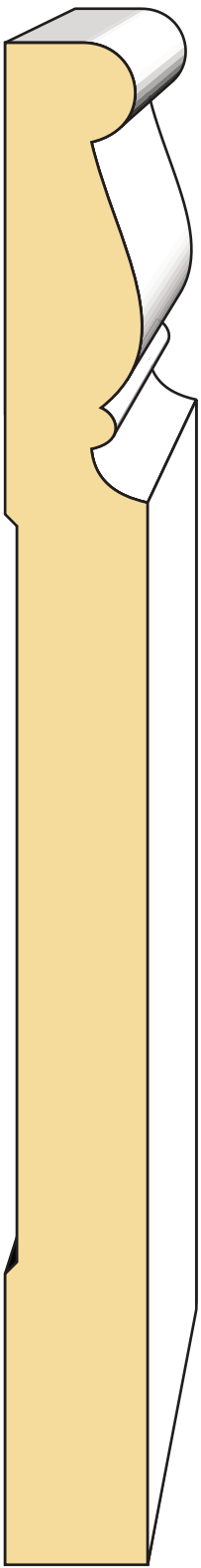

LDF BA8
3/4" x 8"

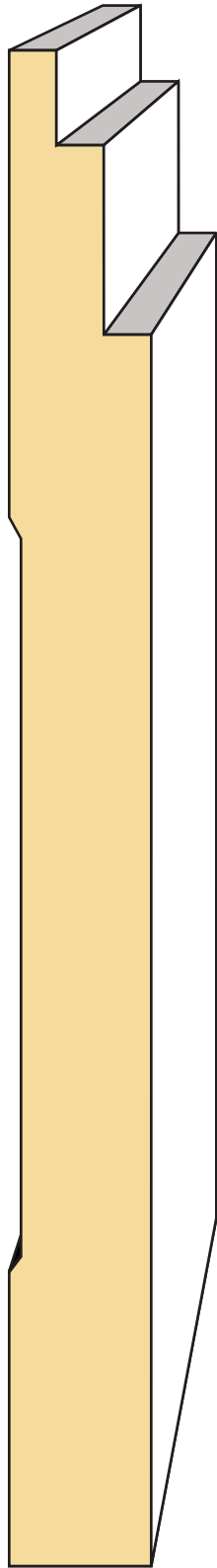

LDF BA8A
3/4" x 8"

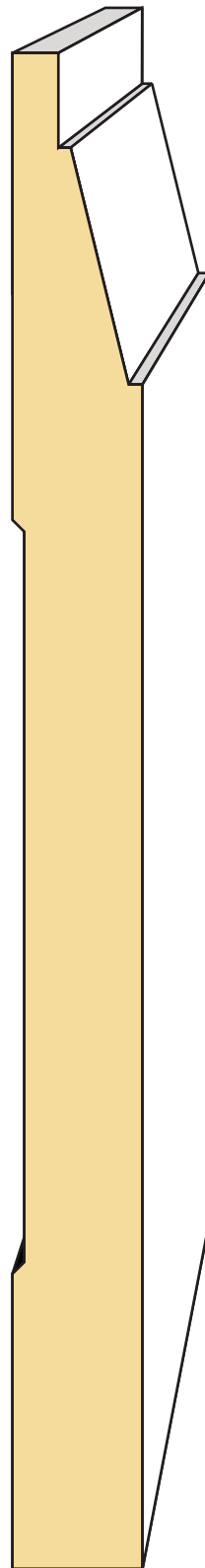

LDF BA8B
11/16" x 8"

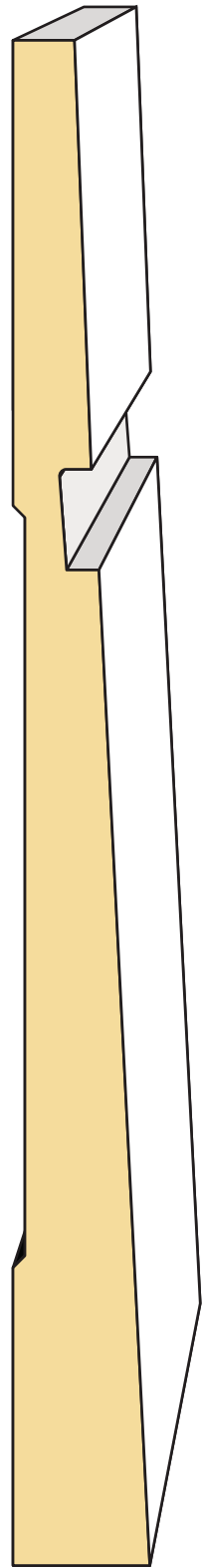

LDF BA8C
11/16" x 8"

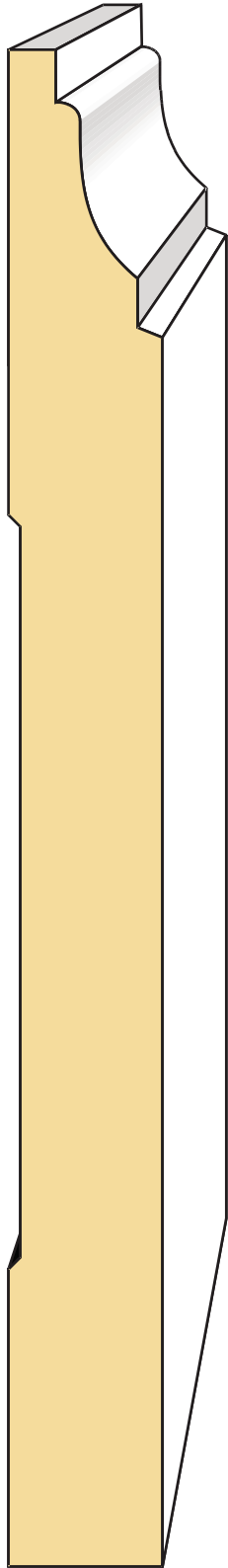

LDF BA8F
13/16" x 8"

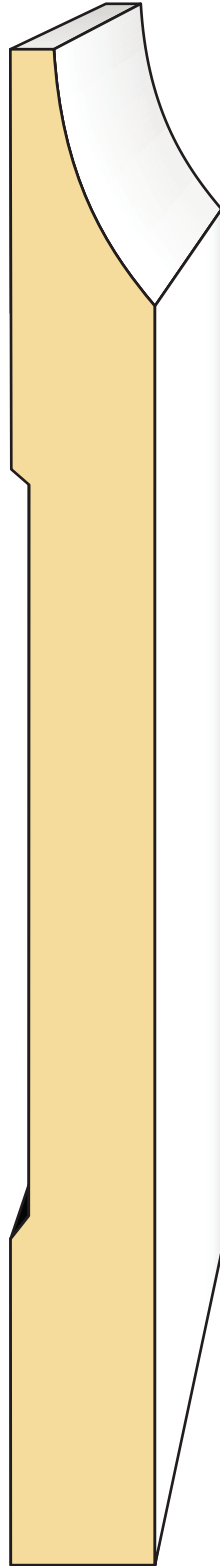

LDF BA818
3/4" x 8-1/8"

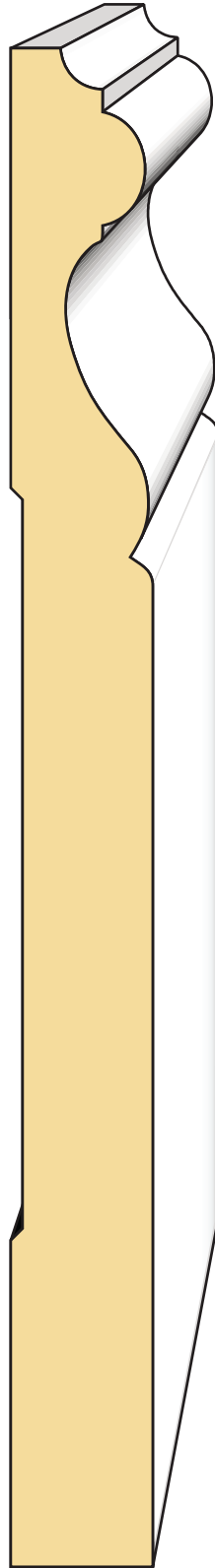

LDF BA814
3/4" x 8-1/4"

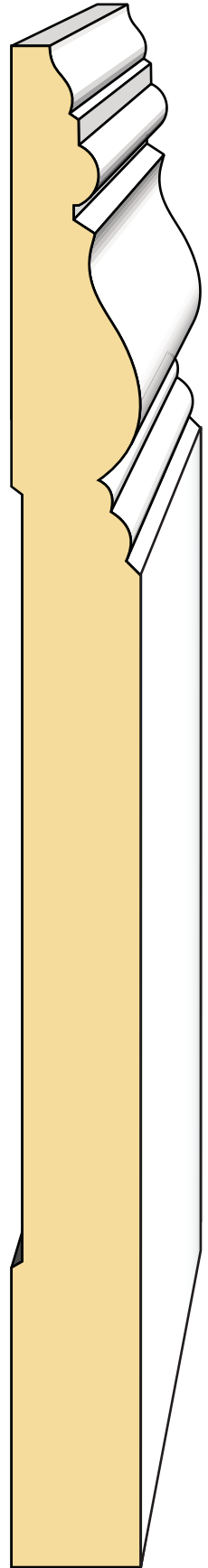

LDF BA914
3/4" x 9-1/4"

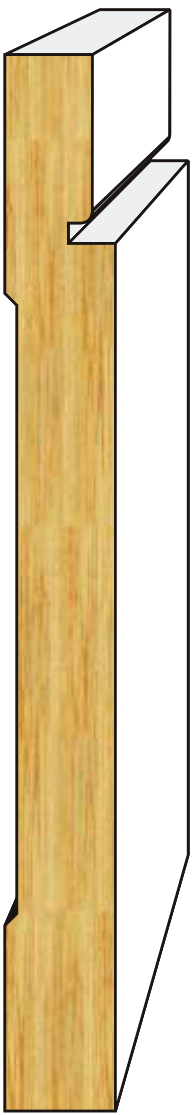

BA 512NPP
9/16" x 5-1/2"

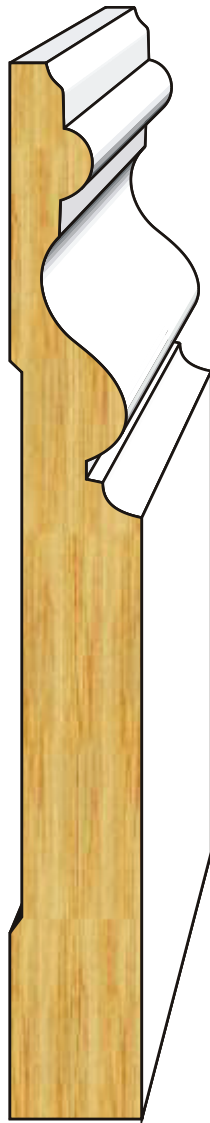

BA 512PP
11/16" x 5-1/2"



BA 534PP
9/16" x 5-3/4"



BA 534APP
9/16" x 5-3/4"



BA 714APP
13/16" x 7-1/4"



BA 714DPP
3/4" x 7-1/4"

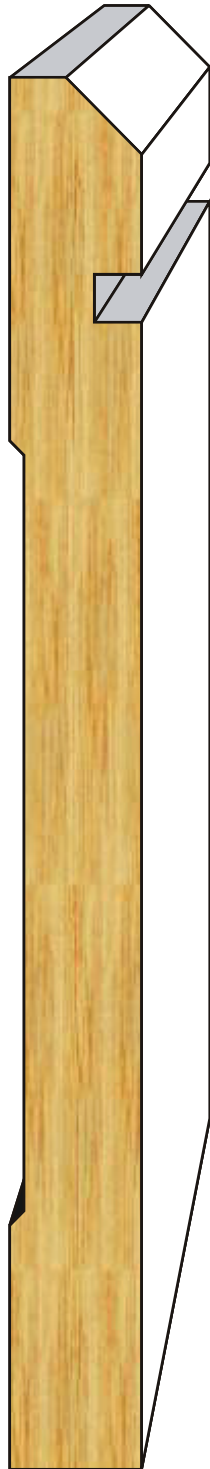

BA 714EPP
11/16" x 7-1/4"



BA 714HPP
3/4" x 7-1/4"

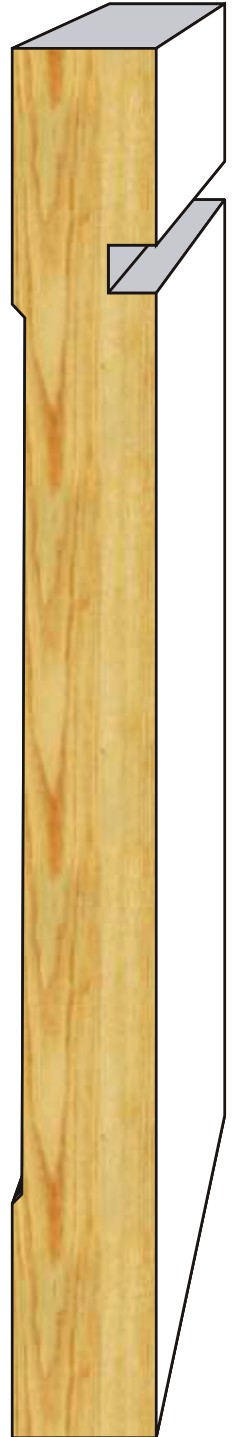

BA 714NPP
3/4" x 7-1/4"

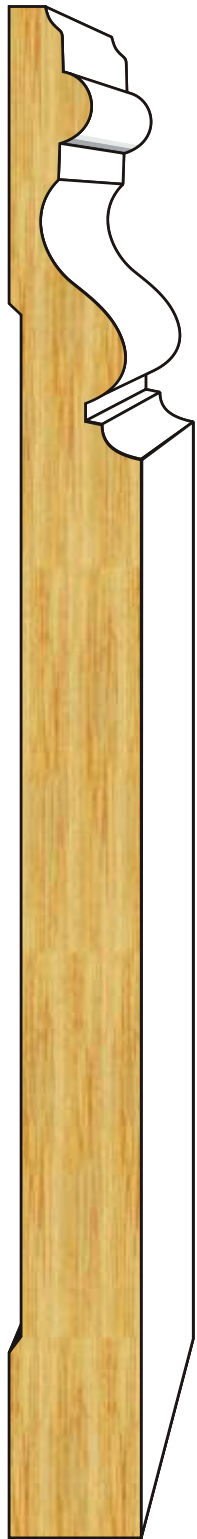

BA 8PP
11/16" x 8"



BA 8BPP
11/16" x 8"



BA 8FPP
13/16" x 8"



BA 818PP
3/4" x 8-1/8"



BA 612
1 1/16" x 6-1/2"



BA 718
1 1/16" x 7-1/8"



BA 714H
3/4" x 7-1/4"

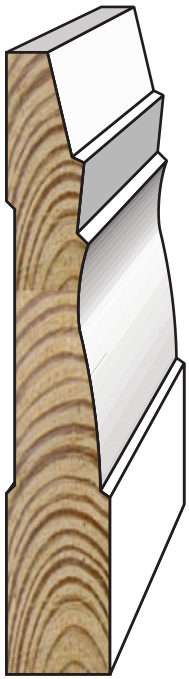

366 B
9/16" x 3-1/4"

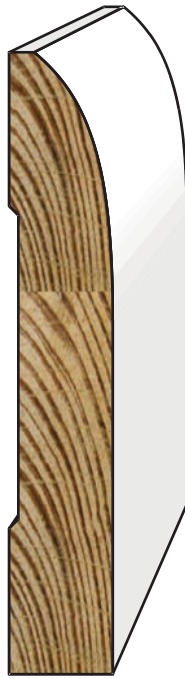

713
9/16" x 3-1/4"



SD 4
9/16" x 4-1/4"



SD 5
9/16" x 5-1/4"



623
9/16" x 3-1/4"



620
9/16" x 4-1/4"



618
9/16" x 5-1/4"



218B
9/16" x 5-1/4"



688
9/16" x 5-1/4"

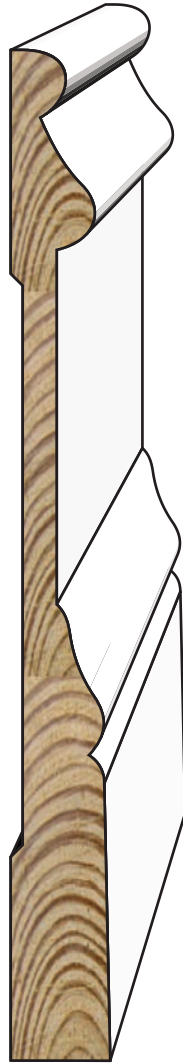

VB
9/16" x 5-1/4"



5180
9/16" x 5-1/4"

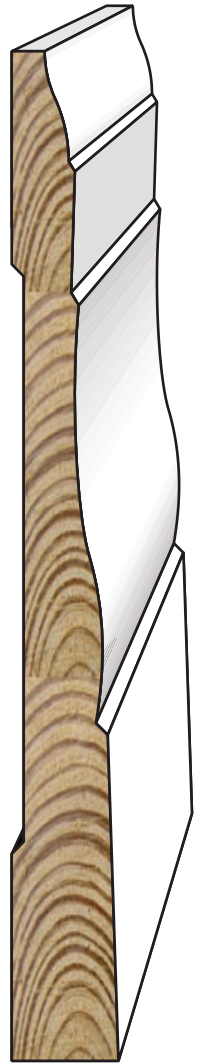

3665B
9/16" x 5-1/4"



VB6
11/16" x 6-1/4"



PM6
11/16" x 6-1/4"



6180
11/16" x 6-1/4"



725
11/16" x 7-1/4"



812
11/16" x 8-1/2"

Stock Casings

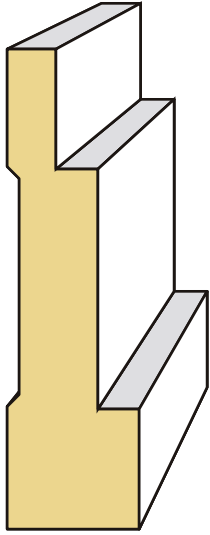

LDF CA212B
11/16" x 2-1/2"

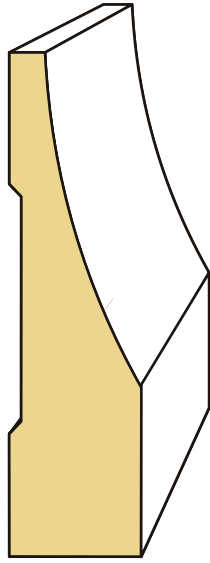

LDF CA258
11/16" x 2-5/8"

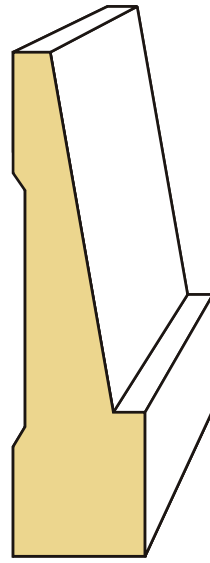

LDF CA258A
11/16" x 2-5/8"

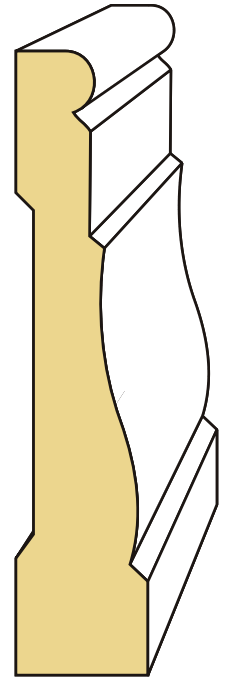

LDF 445
11/16" x 3-1/4"

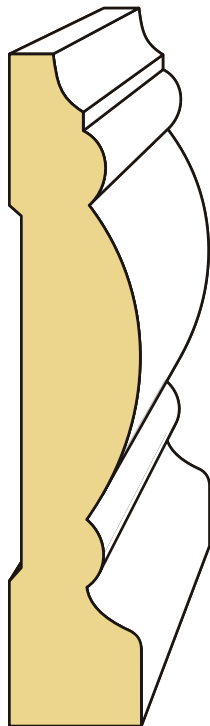

LDF CA312
11/16" x 3-1/2"

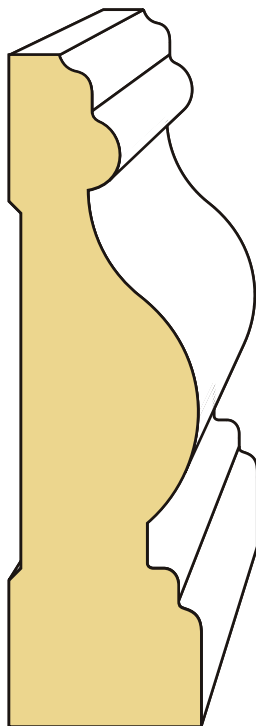

LDF CA312A
1" x 3-1/2"

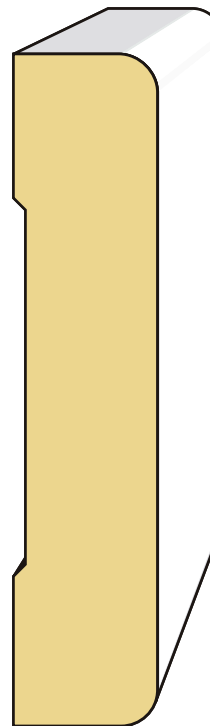

LDF CA312B
11/16" x 3-1/2"

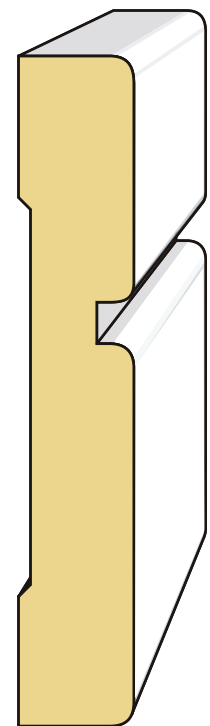

LDF CA312C
5/8" x 3-1/2"

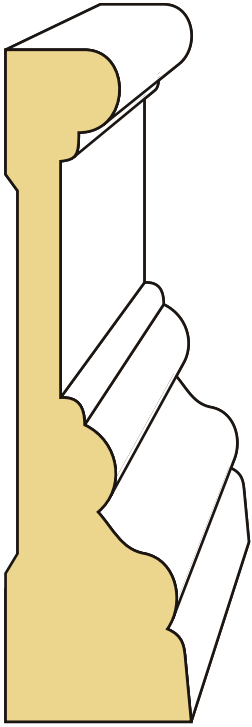

LDF RB3
1" x 3-1/2"

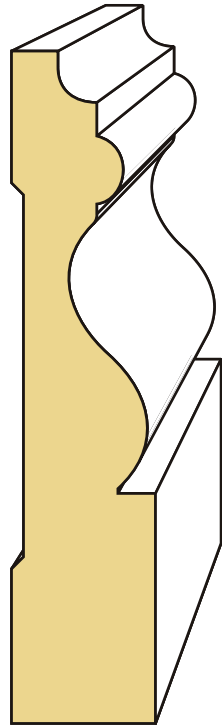

LDF VC
11/16" x 3-1/2"

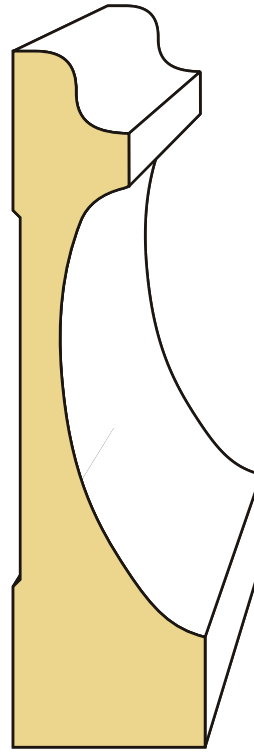

LDF CA358A
1" x 3-5/8"

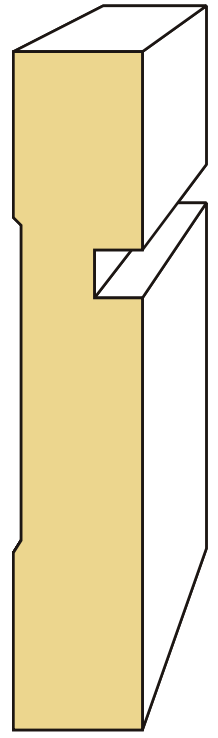

LDF CA312N
11/16" x 3-1/2"

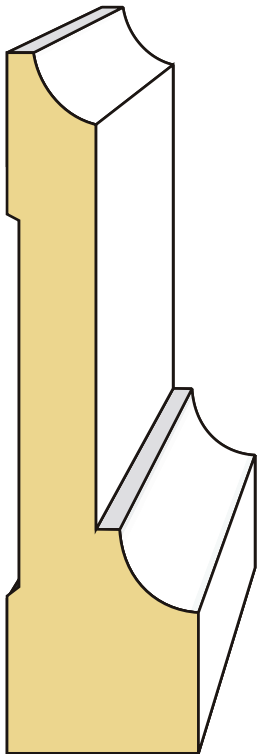

LDF CA358
1" x 3-5/8"

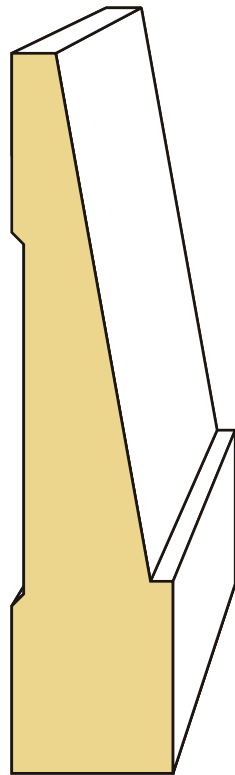

LDF CA334
7/8" x 3-3/4"

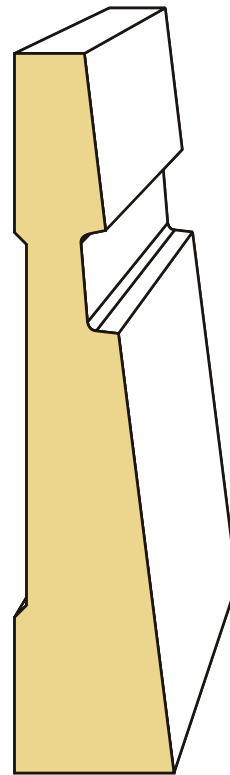

LDF CA334C
13/16" x 3-3/4"

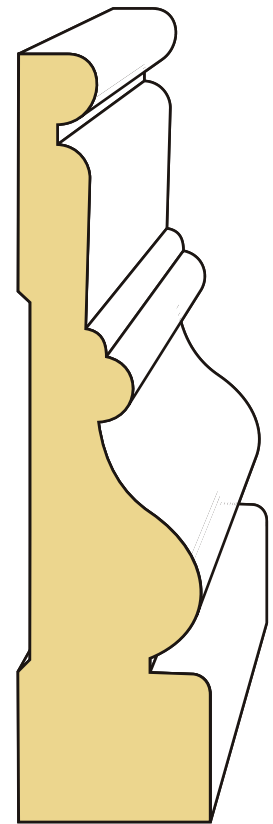

LDF CA4
1" x 4"

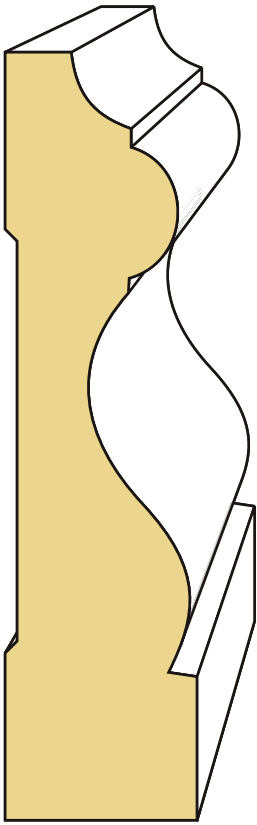

LDF CA4C
1" x 4"

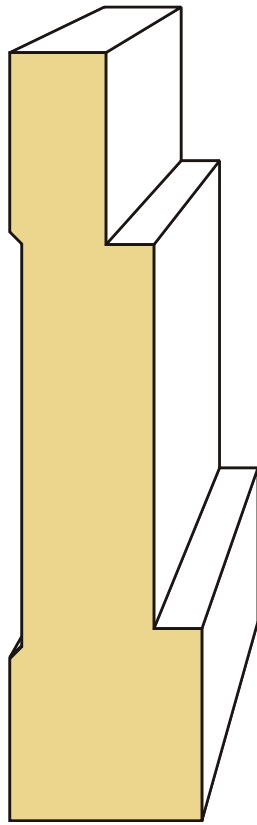

LDF CA4B
1" x 4"

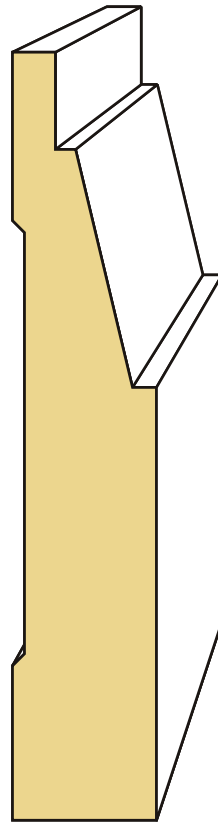

LDF CA4D
13/16" x 4"

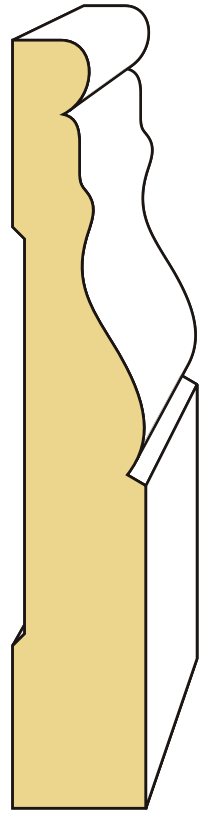

LDF 214
3/4" x 4"



CA 258NPP
11/16" x 2-5/8"

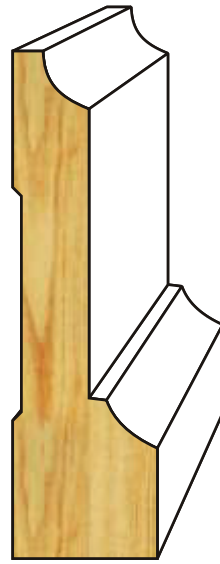

CA 258BPP
3/4" x 2-5/8"

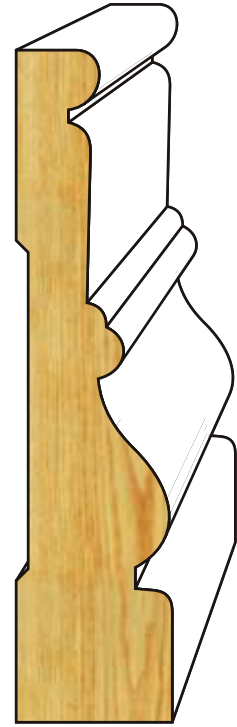

CA 35PP
13/16" x 3-1/2"

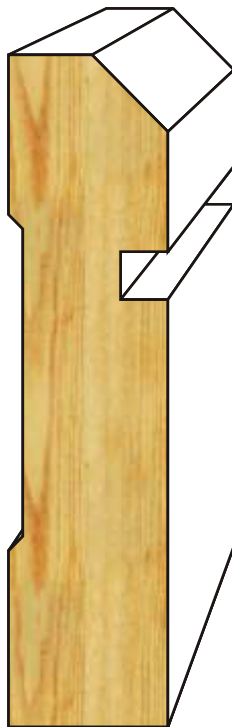

CA 312EPP
13/16" x 3-1/2"

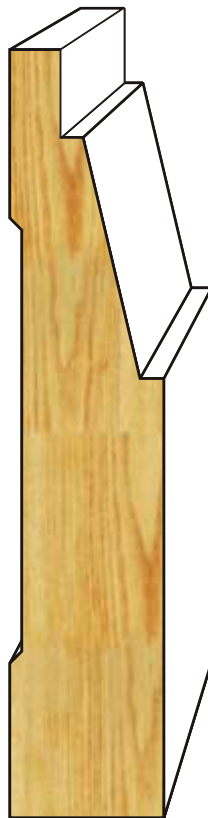

CA 4GPP
1" x 4"

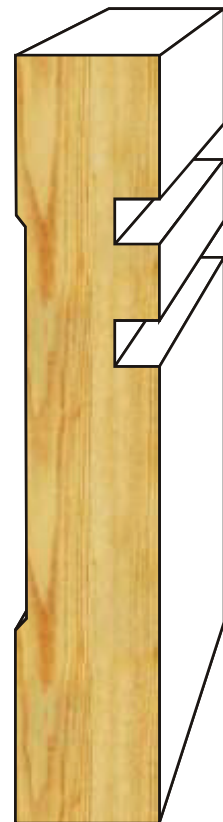

CA 4DPP
3/4" x 4"

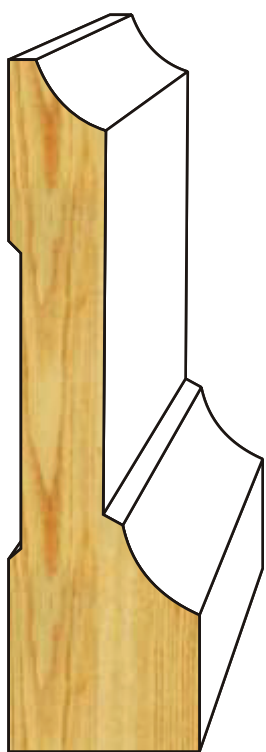

CA 358PP
1" x 3-5/8"

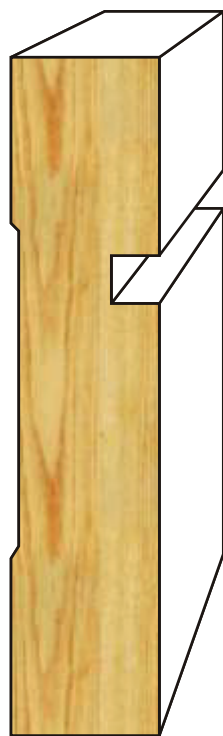

CA 312NPP
3/4" x 3-1/2"

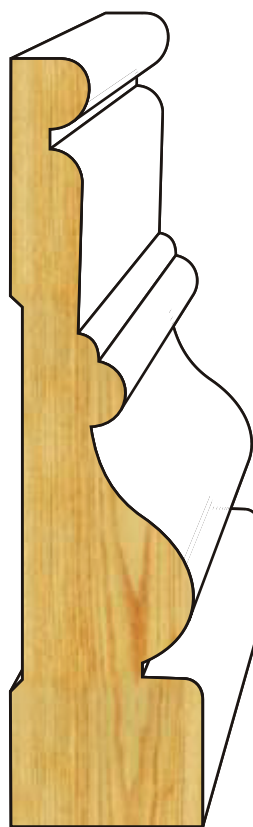

CA 4PP
1" x 4"



CA 4CPP
1-1/16" x 4"

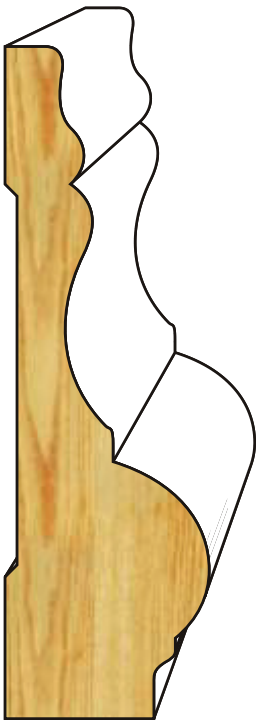

CH 312BPP

1-1/16" x 3-1/2"

Used as Casing

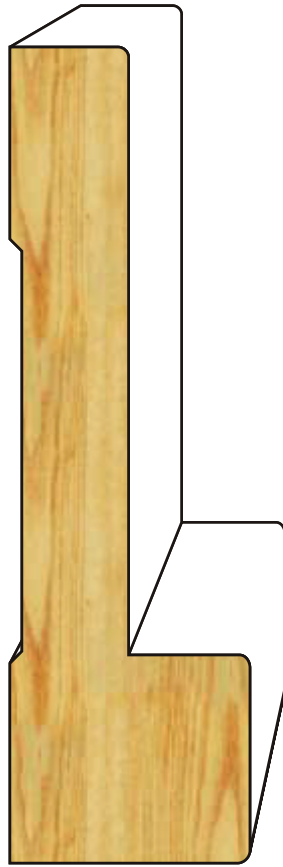

CA 4FPP

1-1/4" x 4"

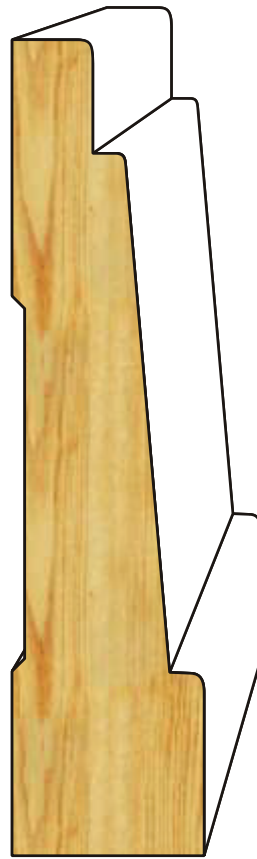

CA 414APP

1" x 4-1/4"

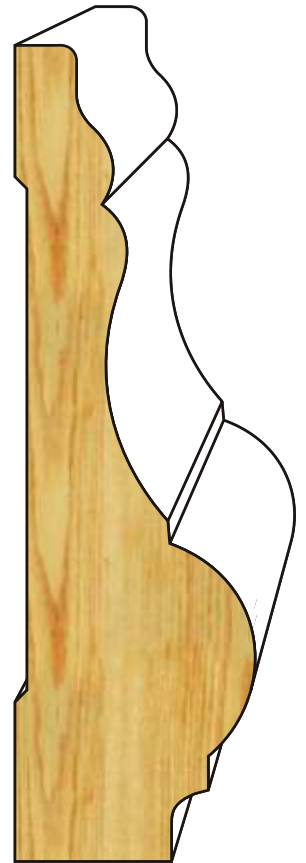

CH 414PP

1-1/4" x 4-1/4"

Used as Casing

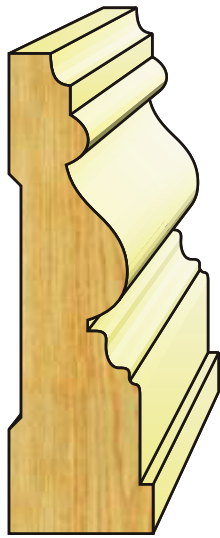

CA 212A
3/4" x 2-1/2"



CA 314
3/4" x 3-1/4"

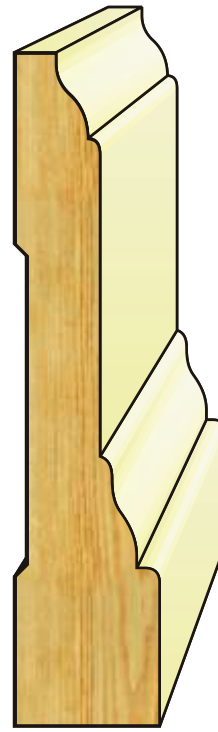

CA 35A
3/4" x 3-1/2"



316L

11/16" x 2-1/4"

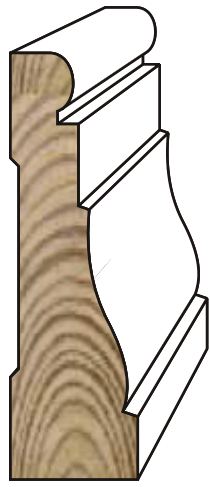

376L

11/16" x 2-1/4"

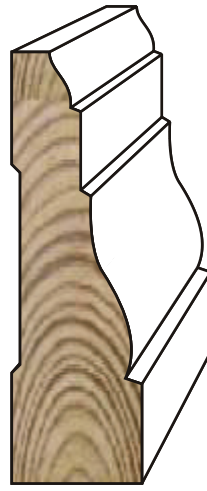

366L

11/16" x 2-1/4"

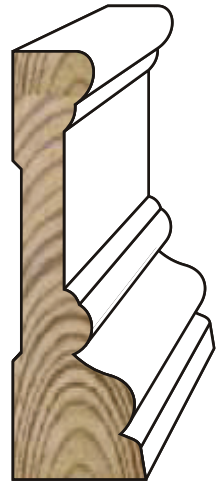

BHOWE

11/16" x 2-1/4"



462

11/16" x 2-3/4"



445

11/16" x 3-1/4"

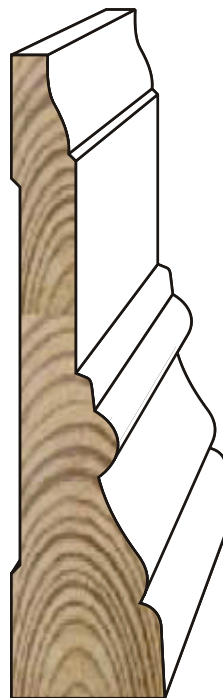

M3

13/16" x 3-3/8"

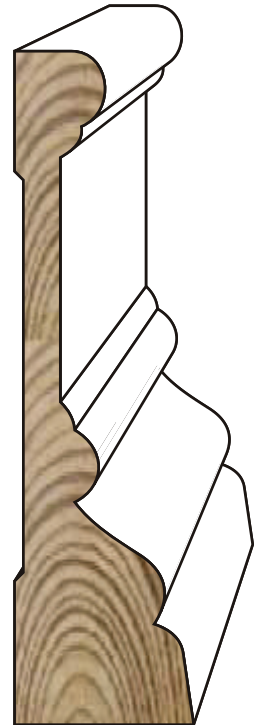

RB3

1" x 3-1/2"



M10 (REEDED)
11/16" x 2-1/4"



M10 (FLUTED)
11/16" x 2-1/4"



M15 (REEDED)
11/16" x 3-1/2"



M15 (FLUTED)
11/16" x 3-1/2"



M4316
1-3/16" x 4-3/16"



VC
11/16" x 3-1/2"



MWSVC
11/16" x 3-1/2"



326
13/16" x 3-1/2"

Stock Crowns

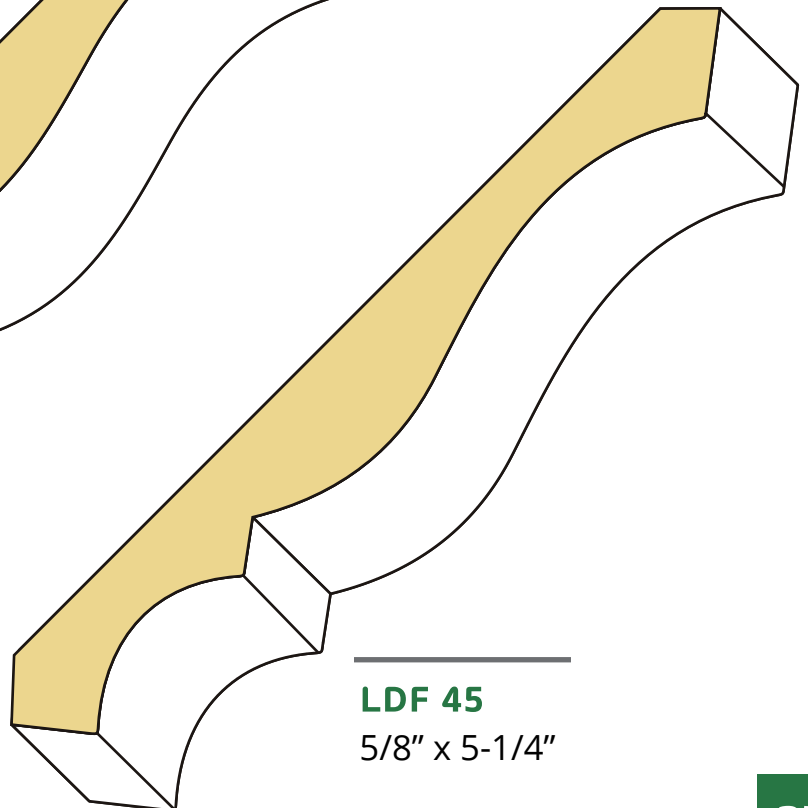
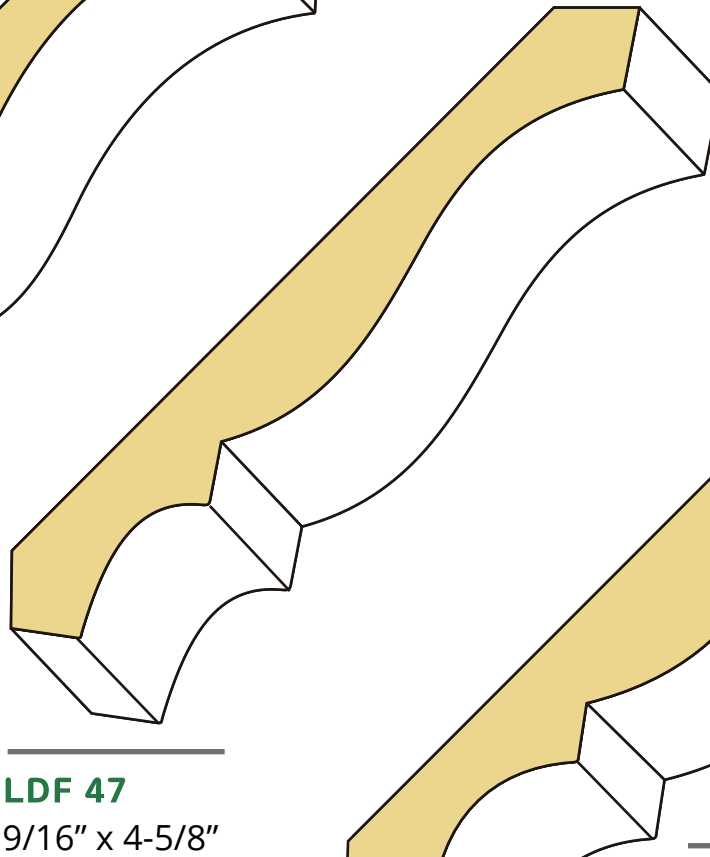
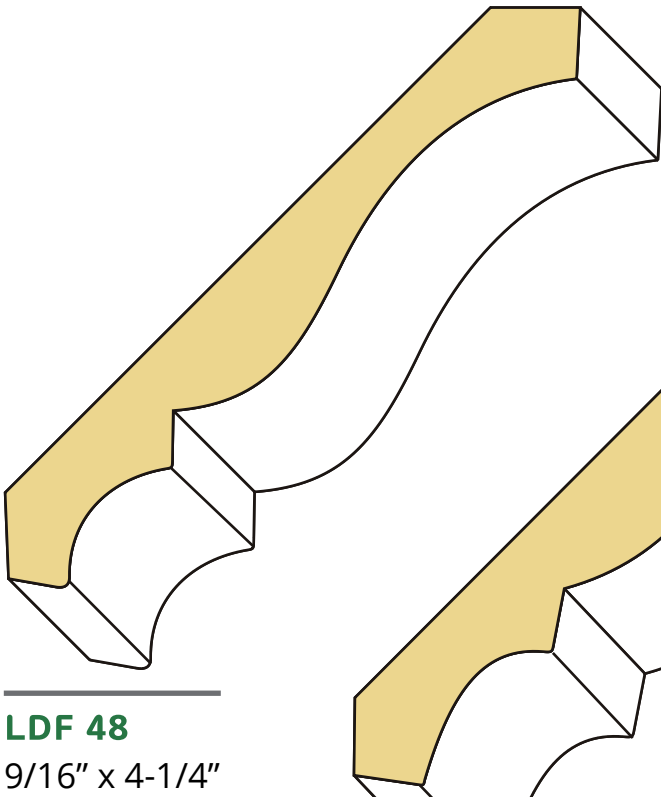
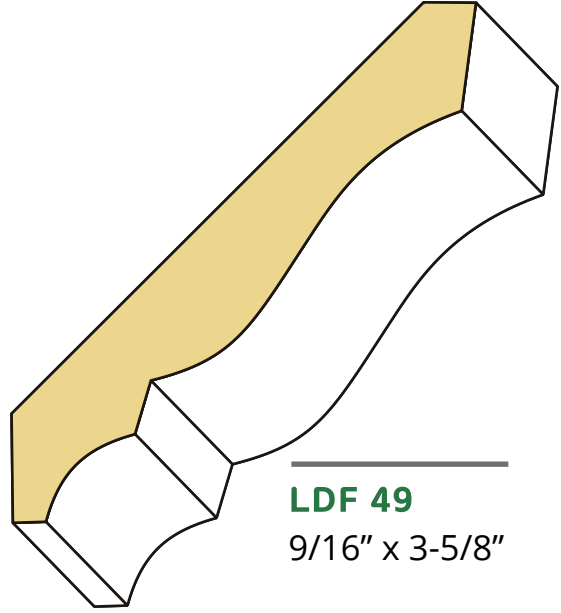
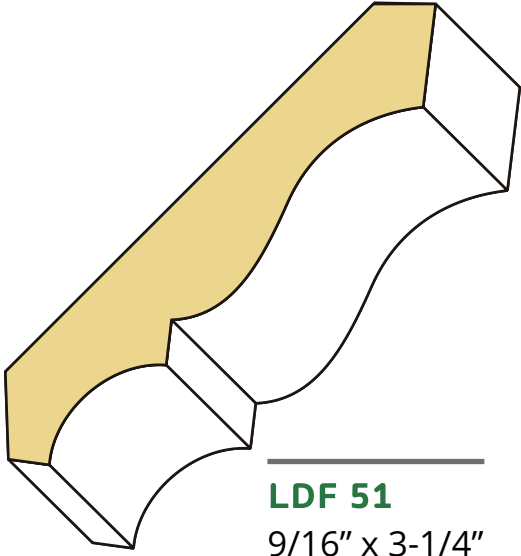

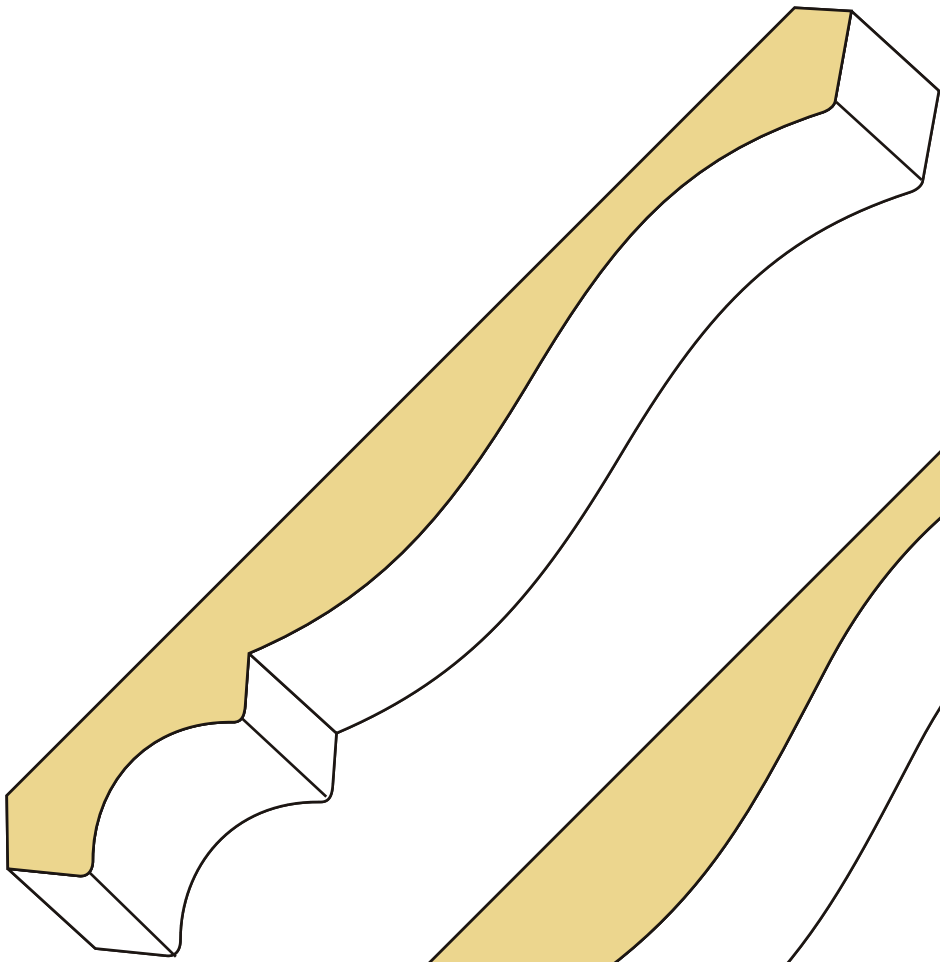

LDF CR625
9/16" x 6-1/4"

The image shows a 3D perspective view of the LDF CR625 crown molding profile. It is a light tan color with a white beveled edge. The profile has a curved top and a decorative, slightly flared bottom edge.

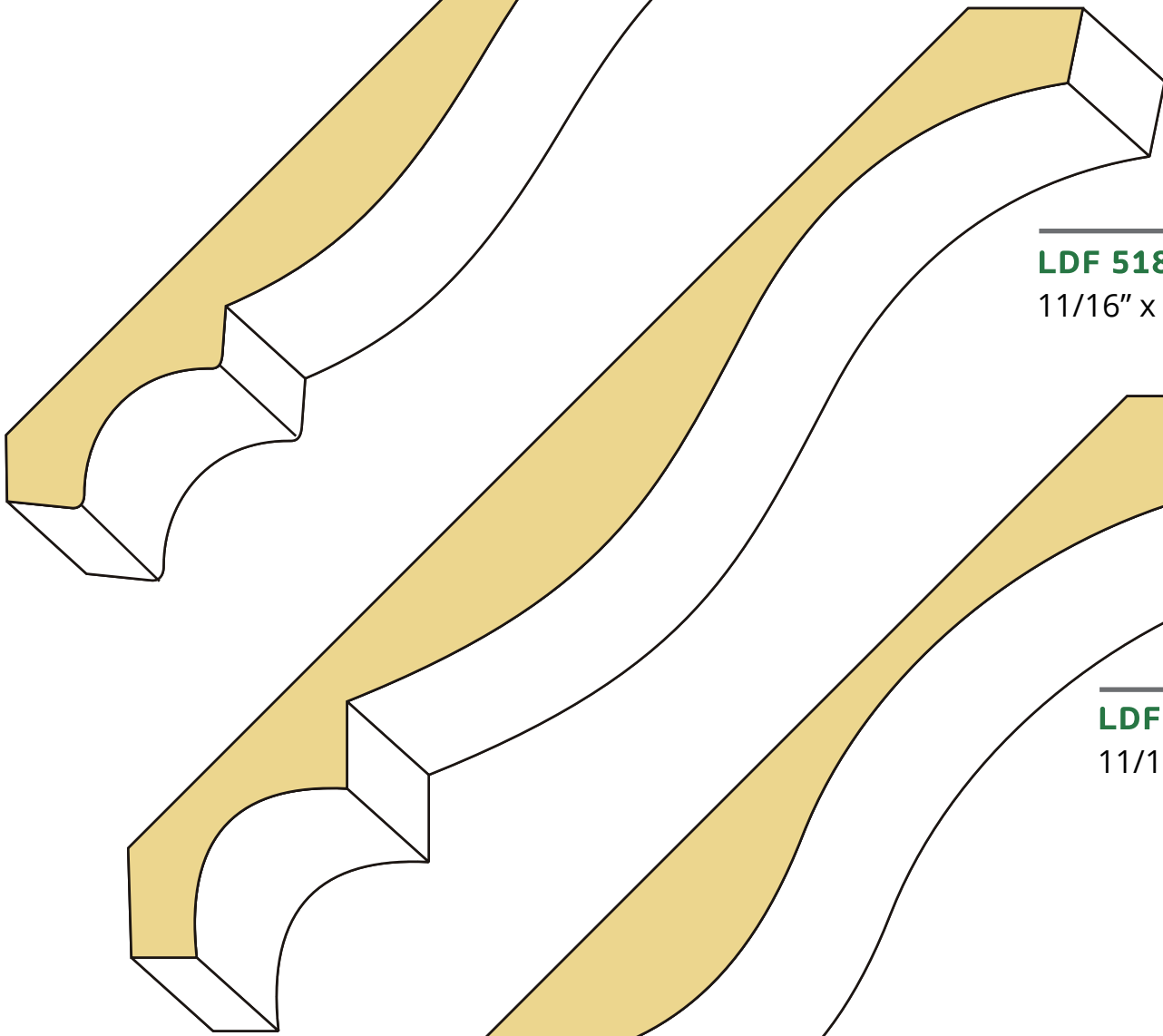

LDF 518
11/16" x 7-3/4"

The image shows a 3D perspective view of the LDF 518 crown molding profile. It is a light tan color with a white beveled edge. The profile has a curved top and a decorative, slightly flared bottom edge.

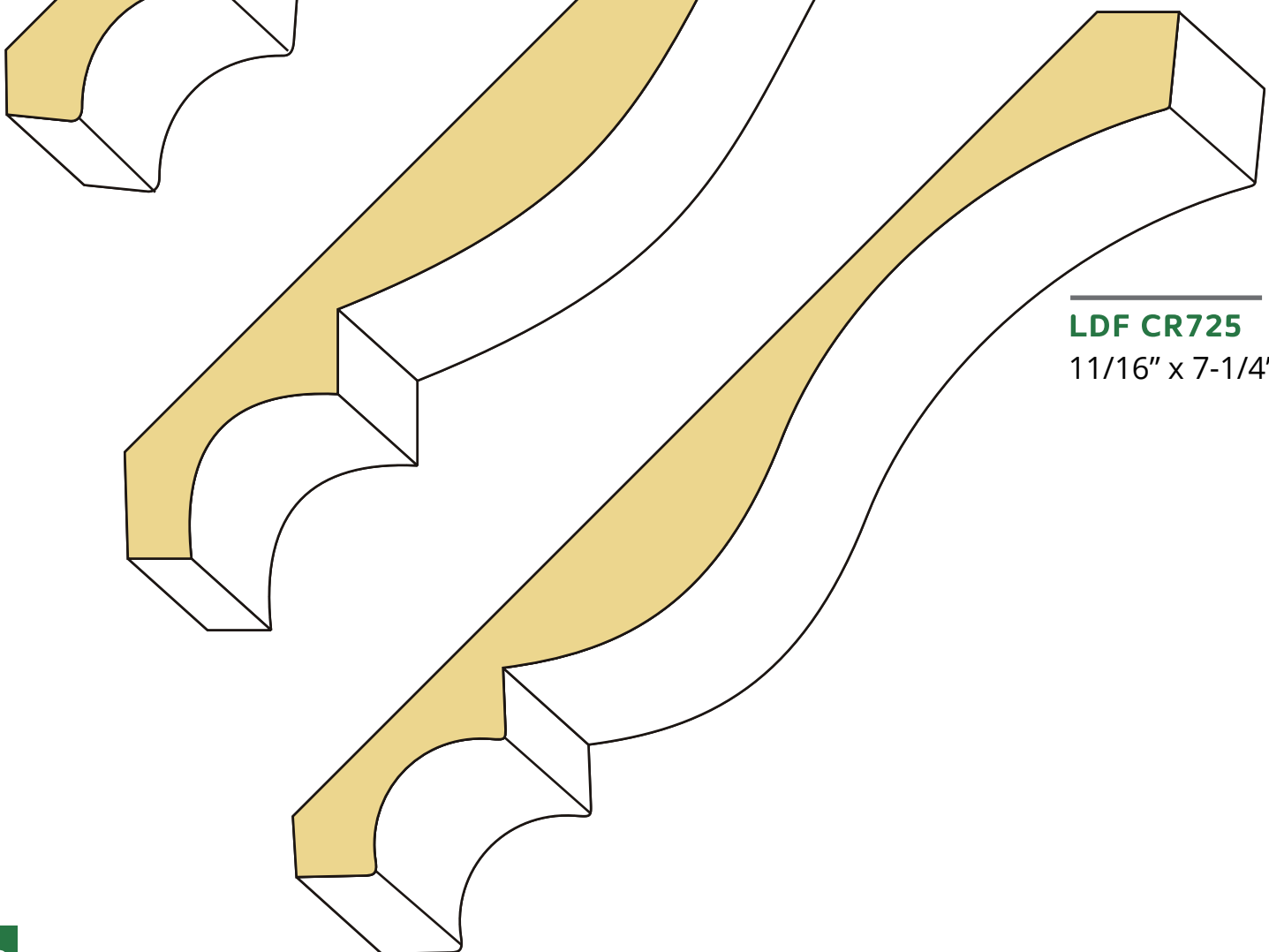

LDF CR725
11/16" x 7-1/4"

The image shows a 3D perspective view of the LDF CR725 crown molding profile. It is a light tan color with a white beveled edge. The profile has a curved top and a decorative, slightly flared bottom edge.

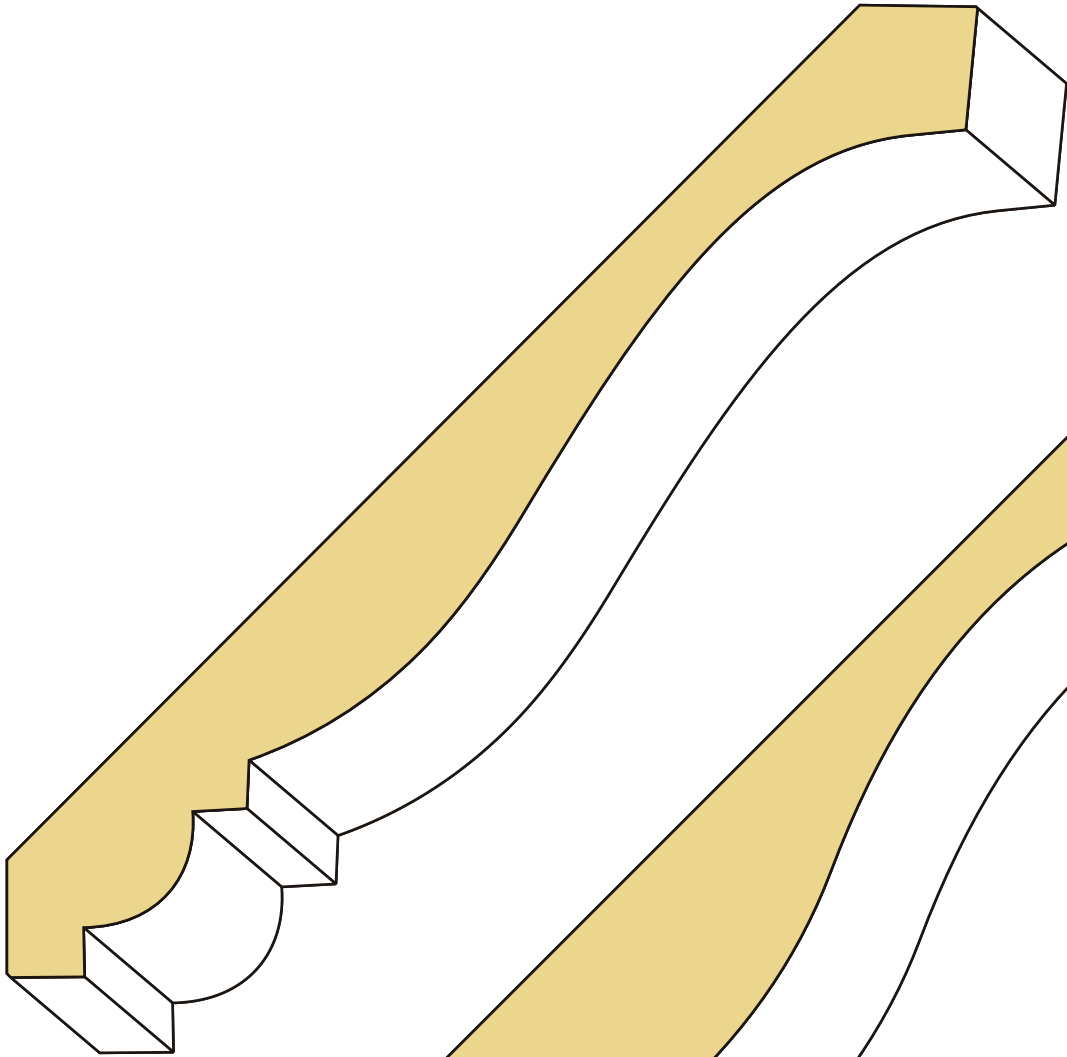

LDF CR718
11/16" x 7-1/8"

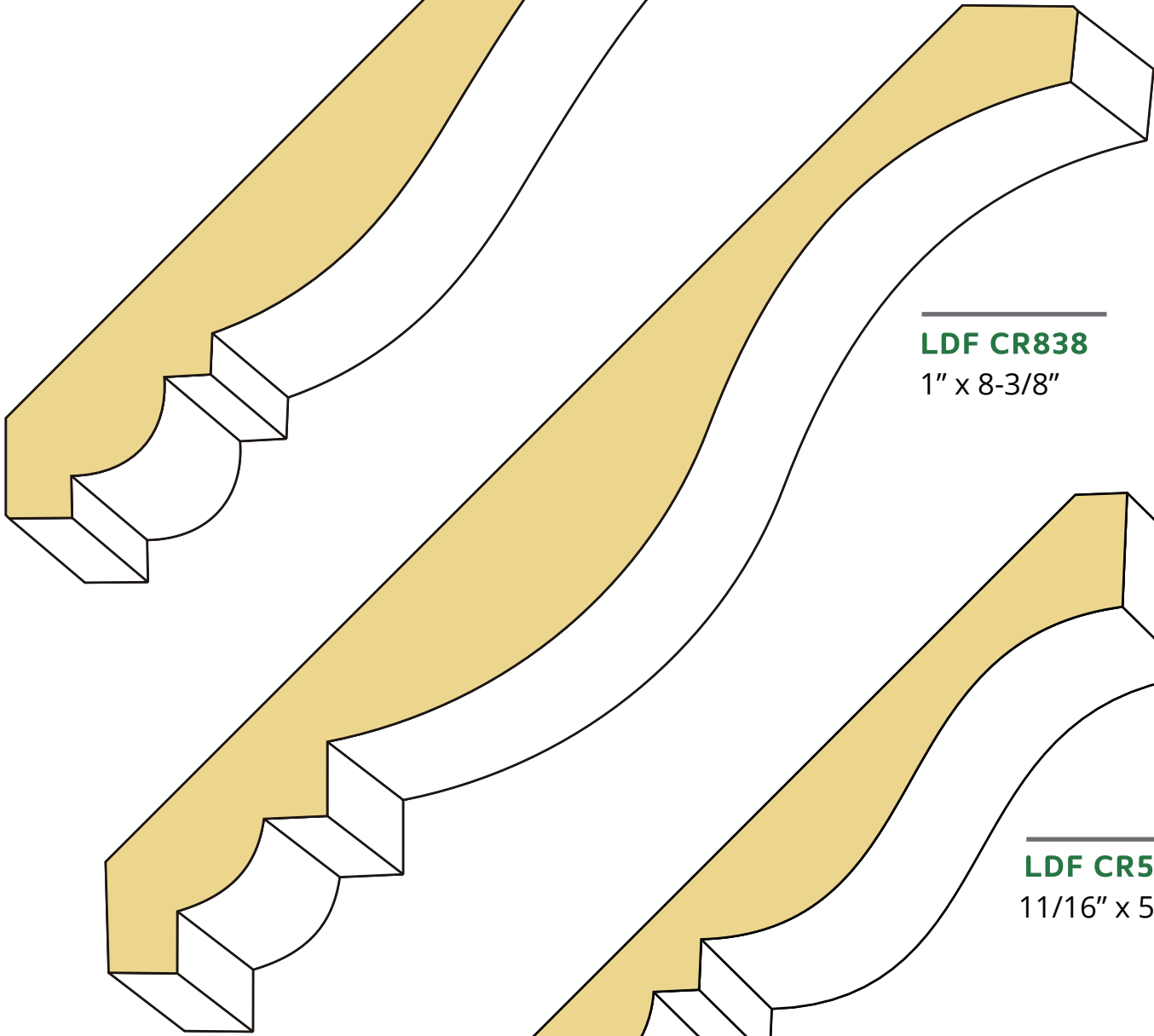

LDF CR838
1" x 8-3/8"

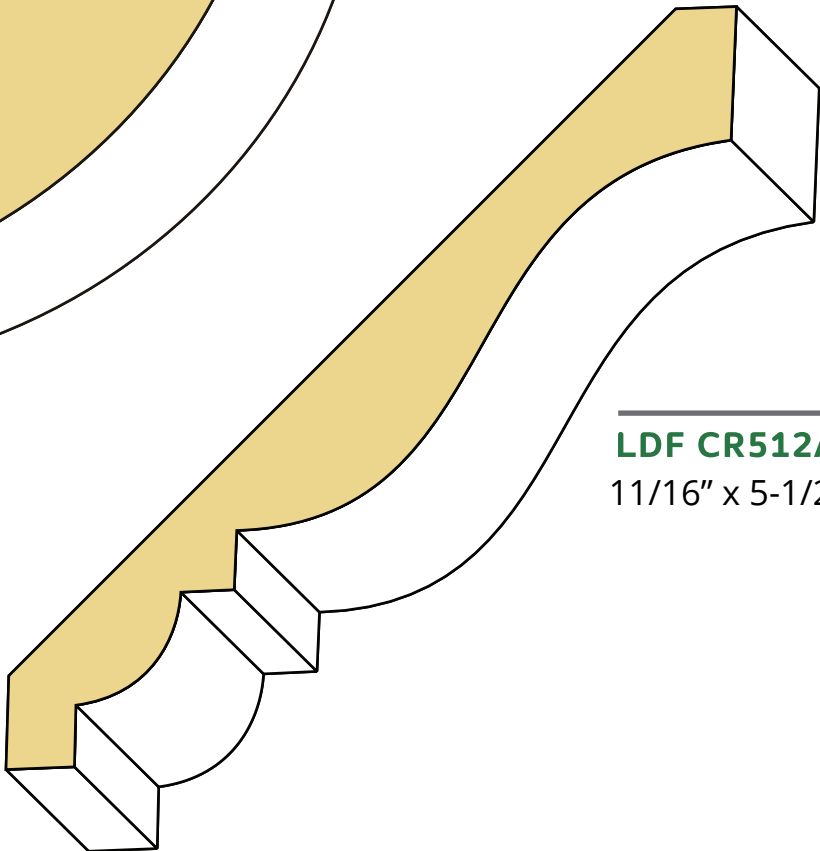

LDF CR512A
11/16" x 5-1/2"

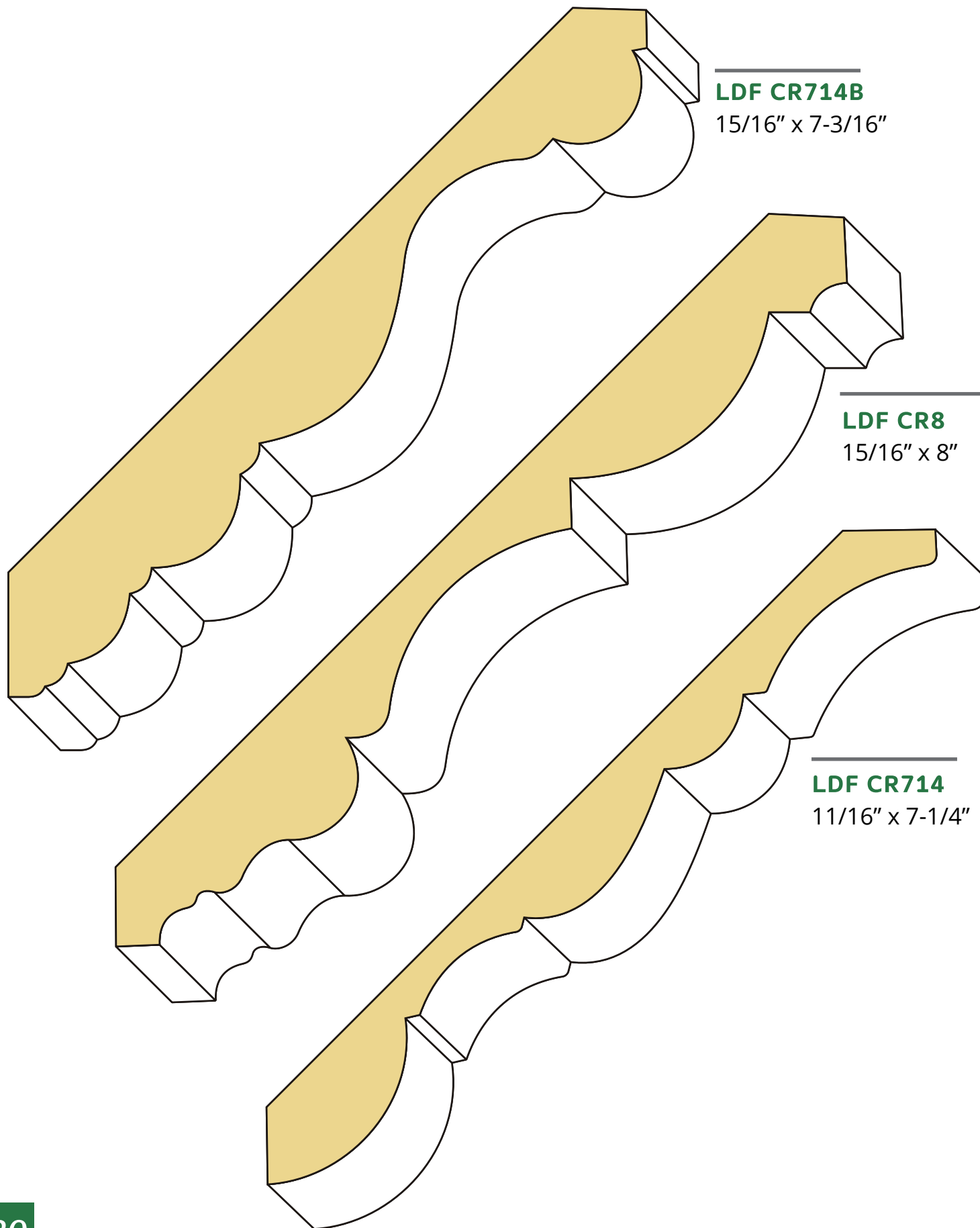

LDF CR458
3/4" x 4-5/8"

LDF CR714A
15/16" x 7-3/16"

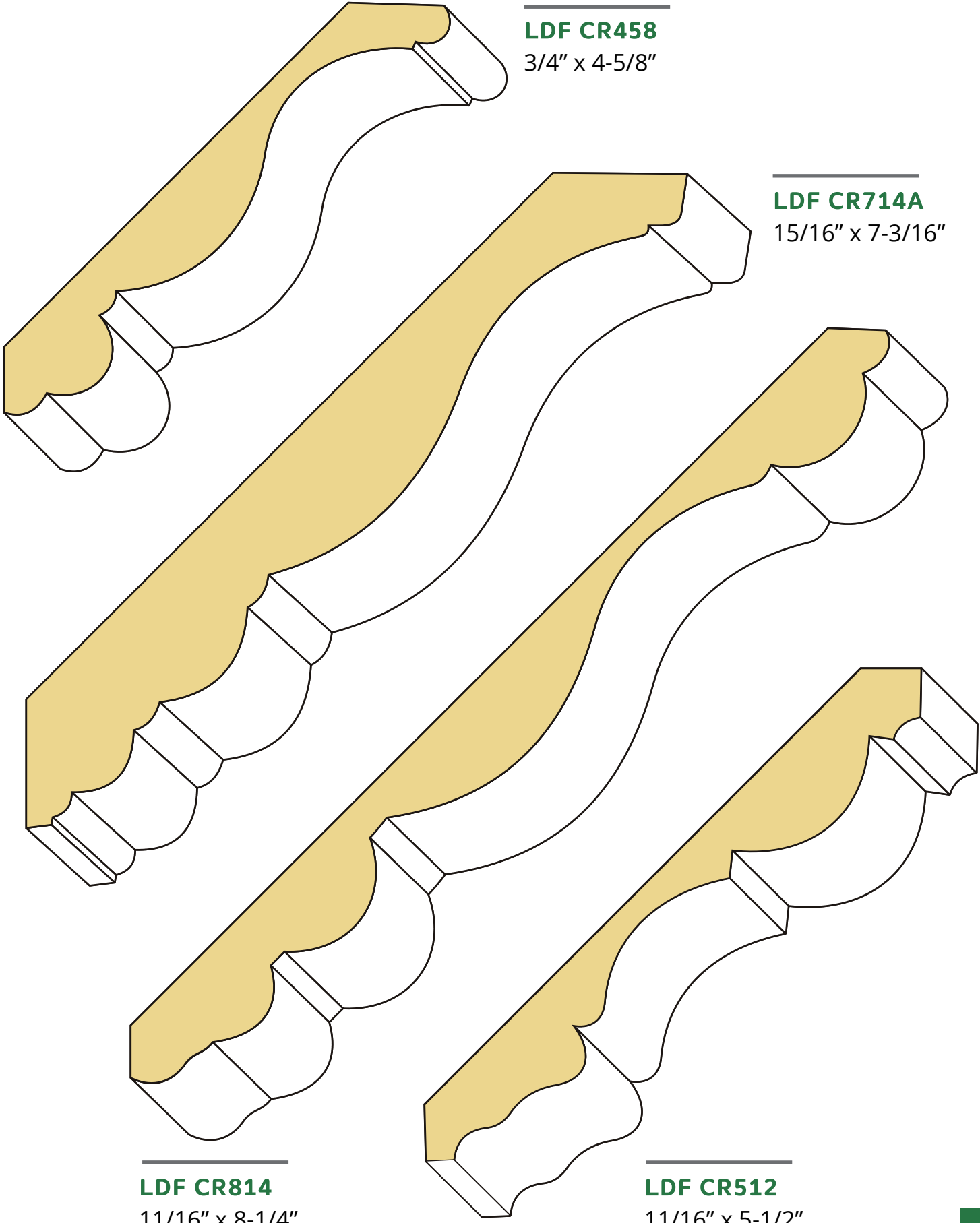

LDF CR814
11/16" x 8-1/4"

LDF CR512
11/16" x 5-1/2"

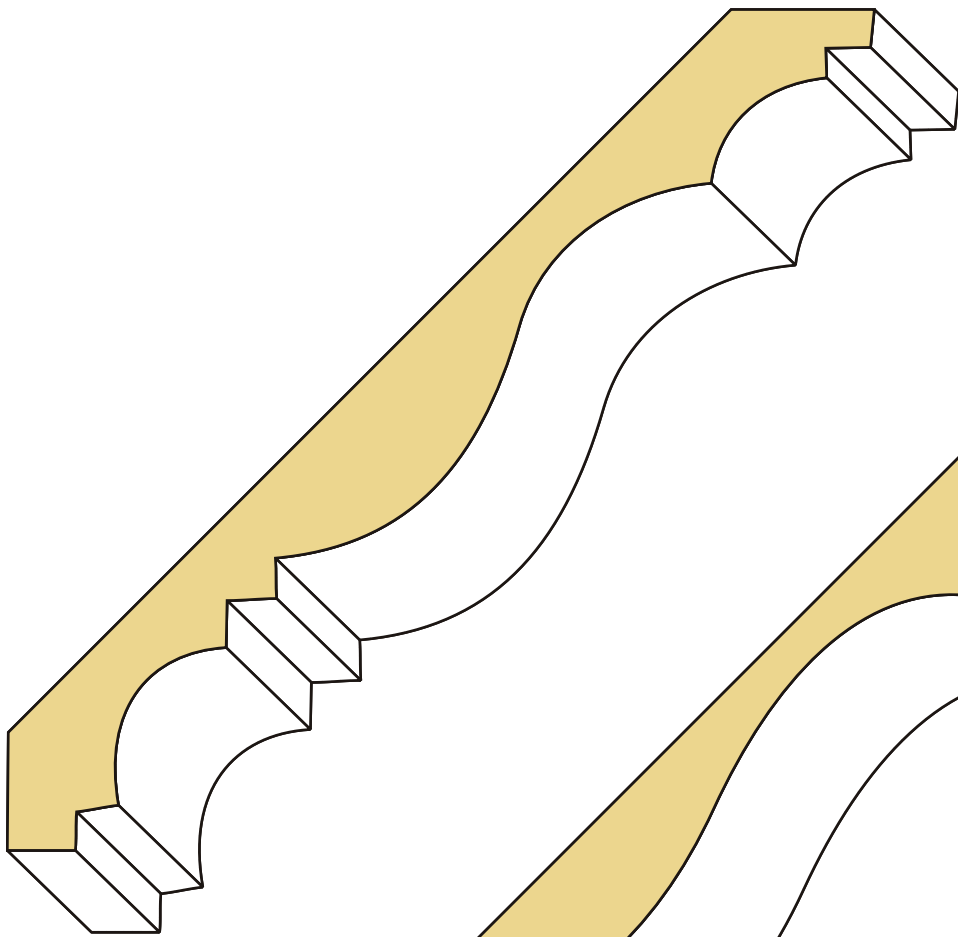

LDF CR614B
1 1/16" x 6-1/4"

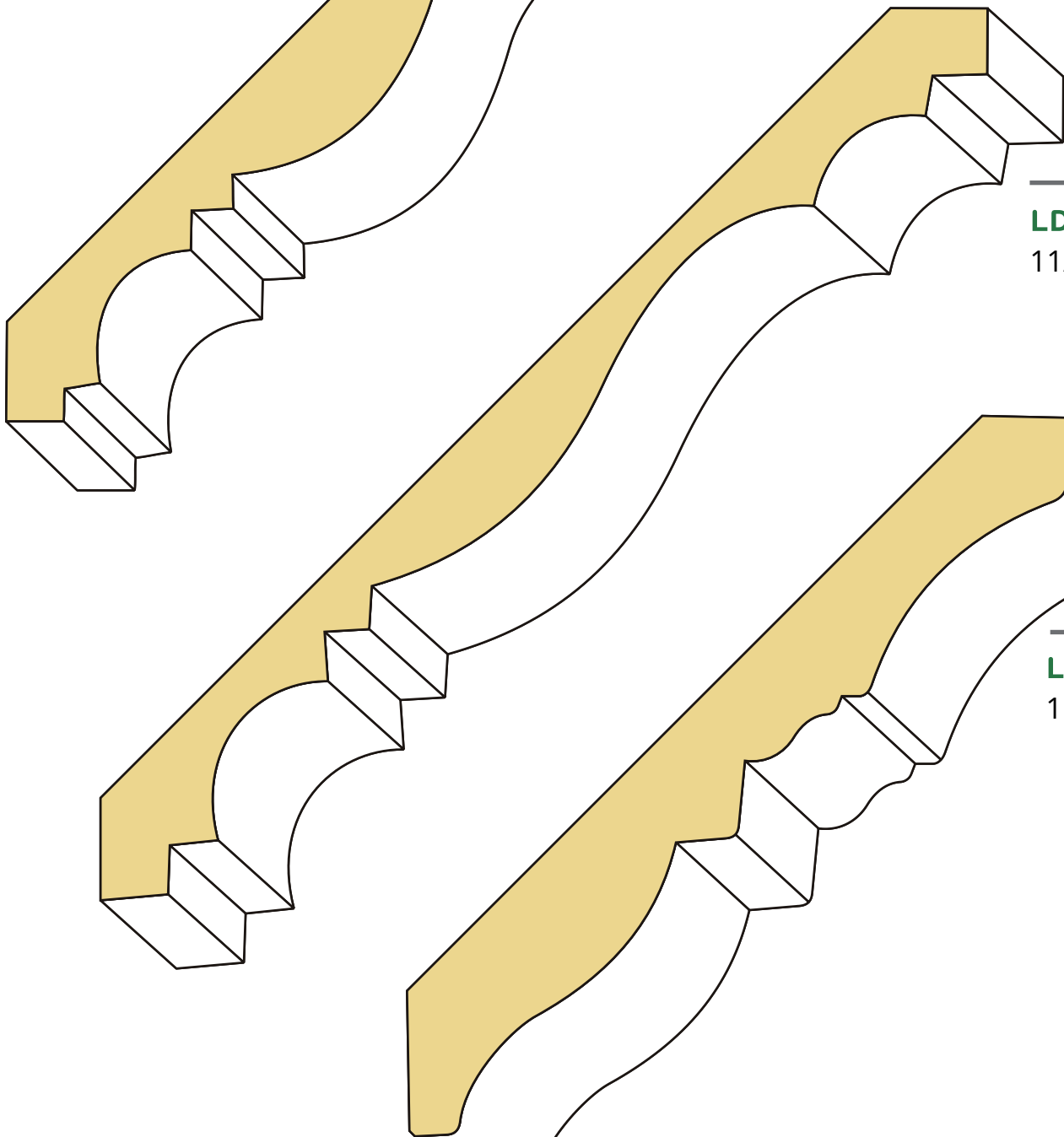

LDF CR734
1 1/16" x 7-3/4"

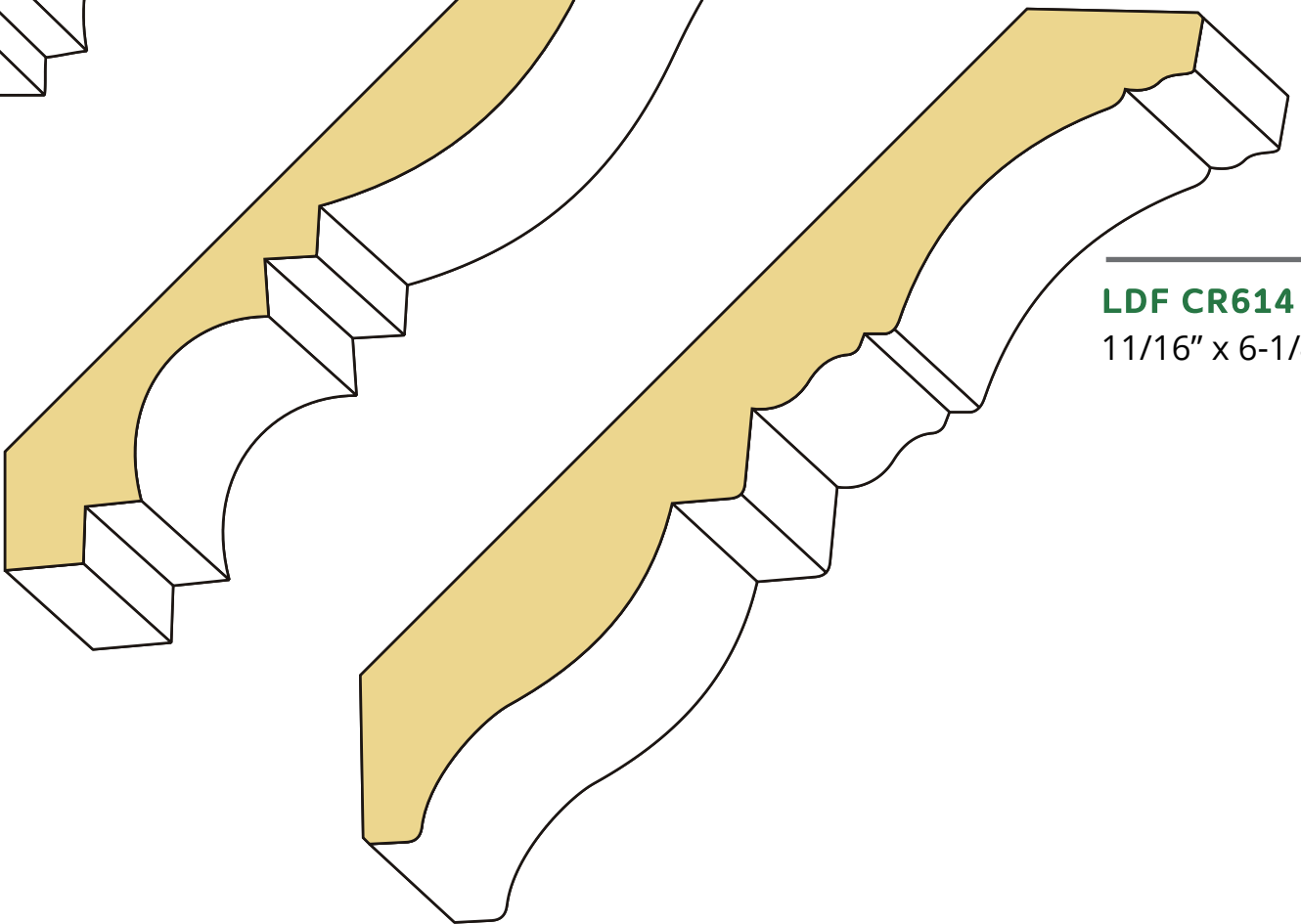

LDF CR614
1 1/16" x 6-1/4"

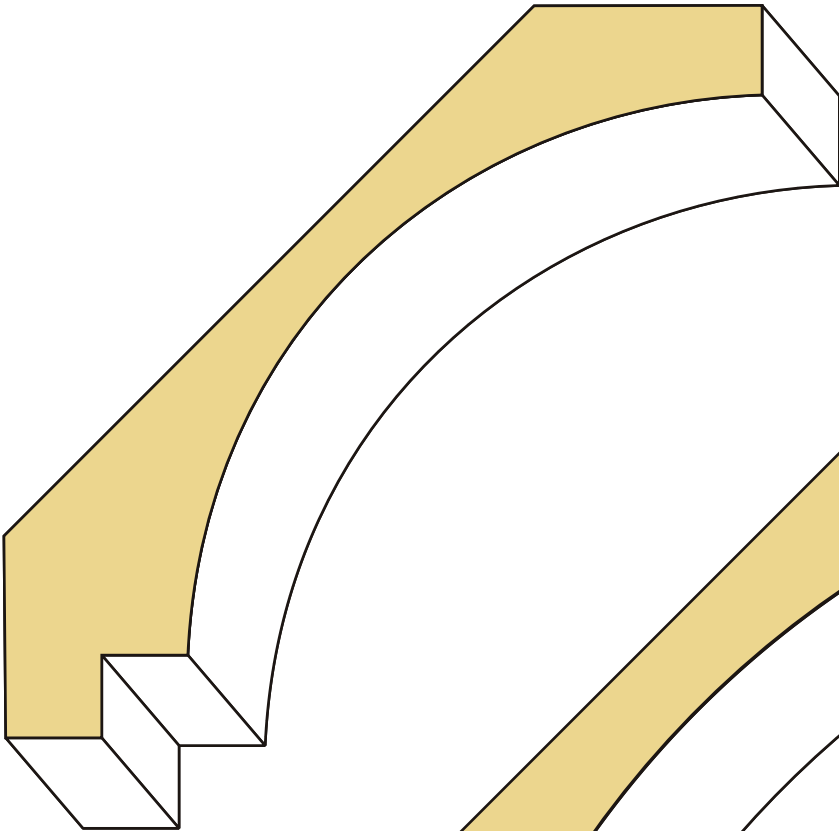

LDF CR512B

1-3/16" x 5-1/2"

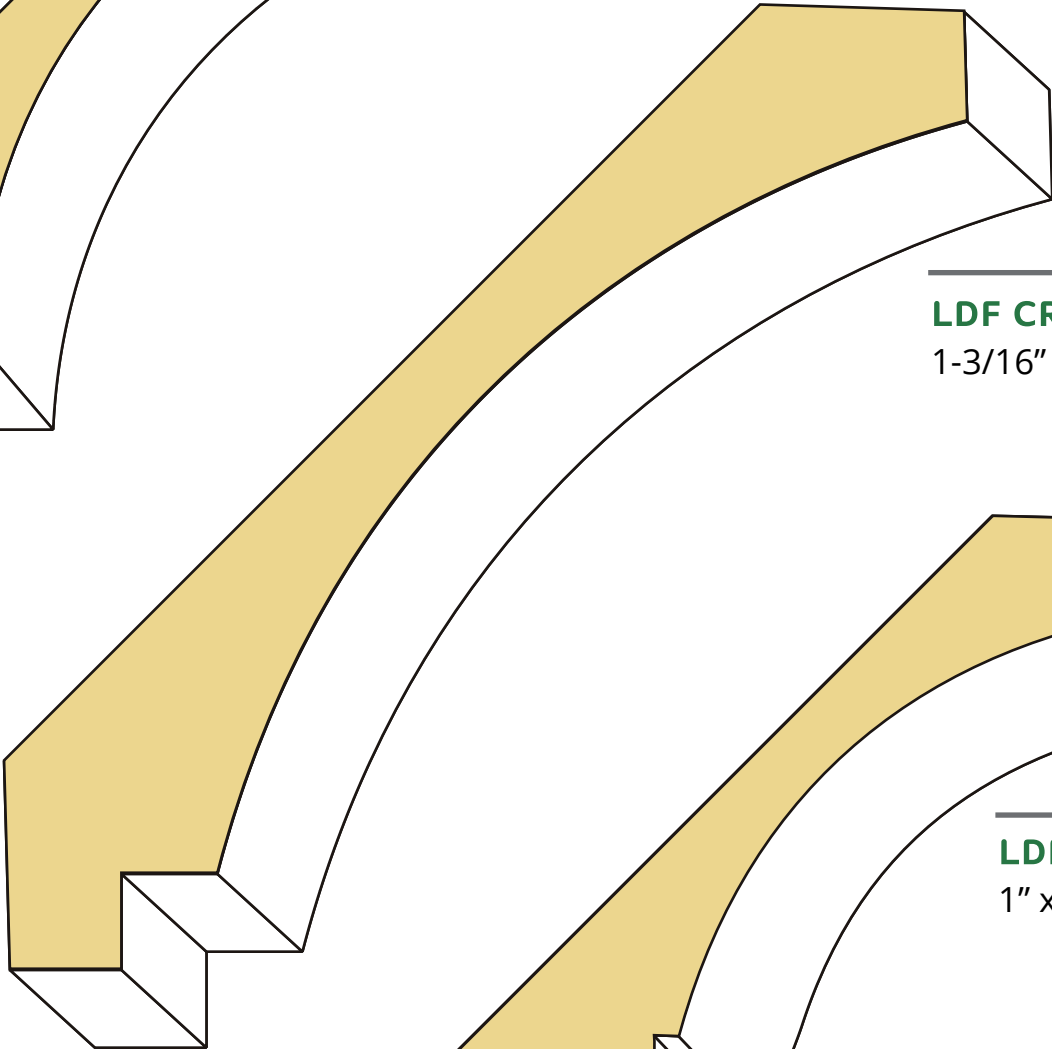

LDF CR7

1-3/16" x 7"

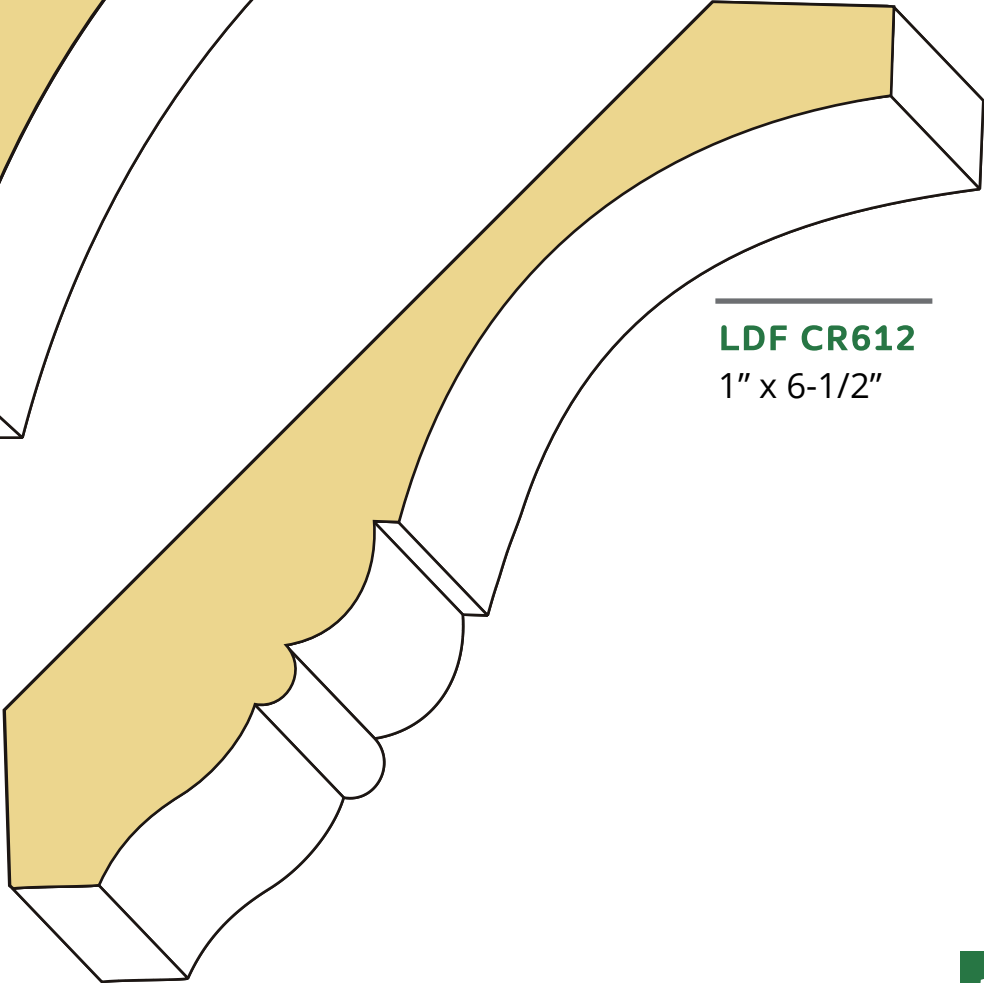

LDF CR612

1" x 6-1/2"

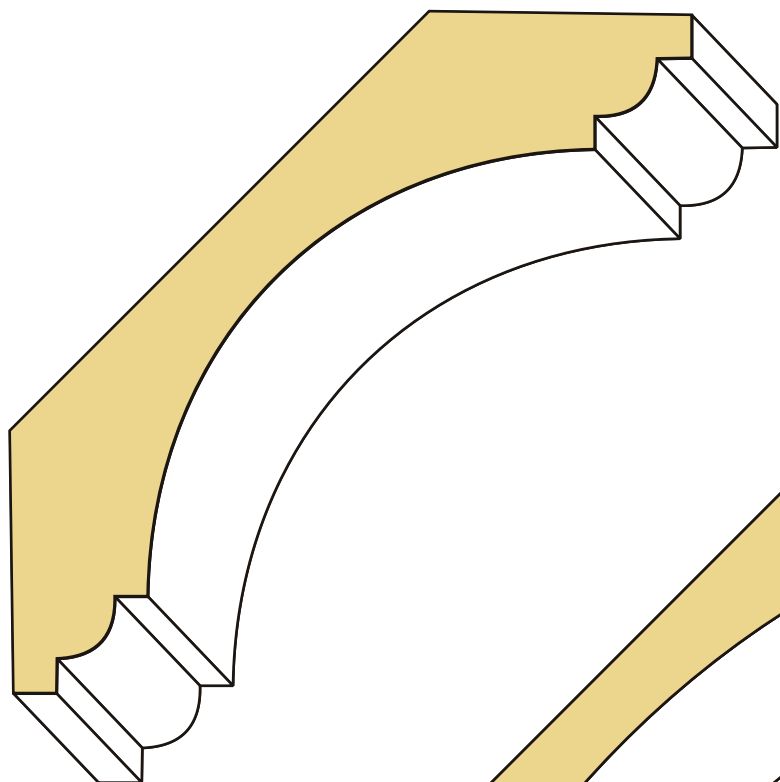

LDF CR5
15/16" x 5"

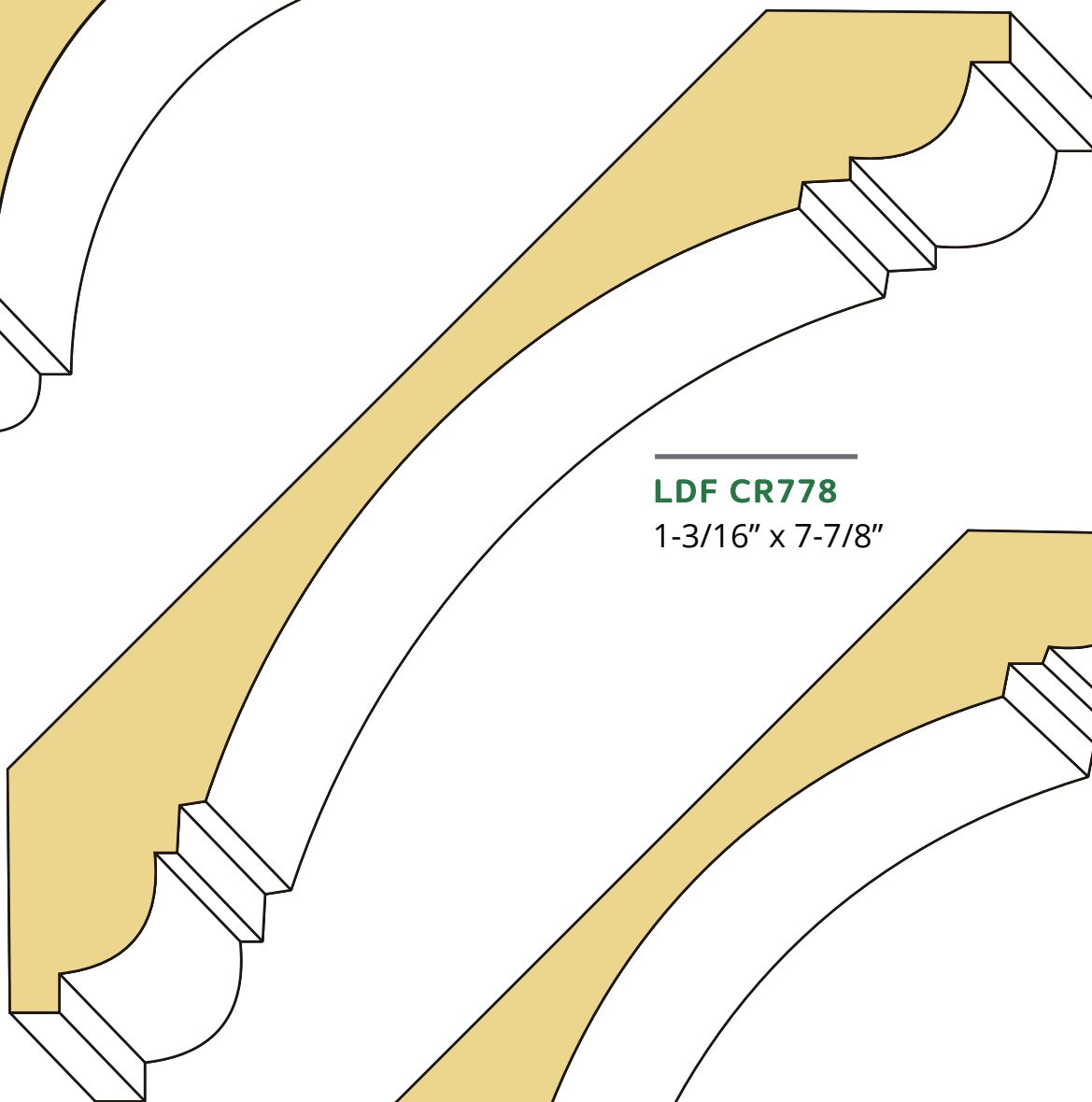

LDF CR778
1-3/16" x 7-7/8"

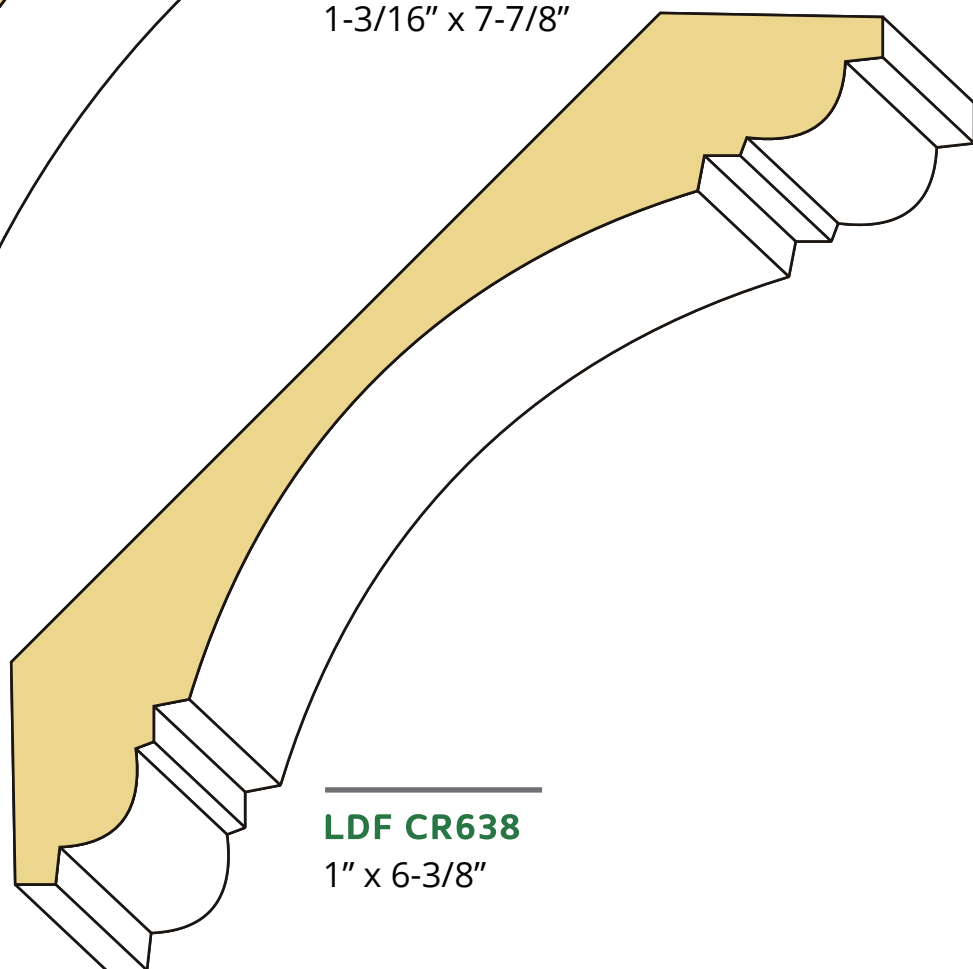

LDF CR638
1" x 6-3/8"

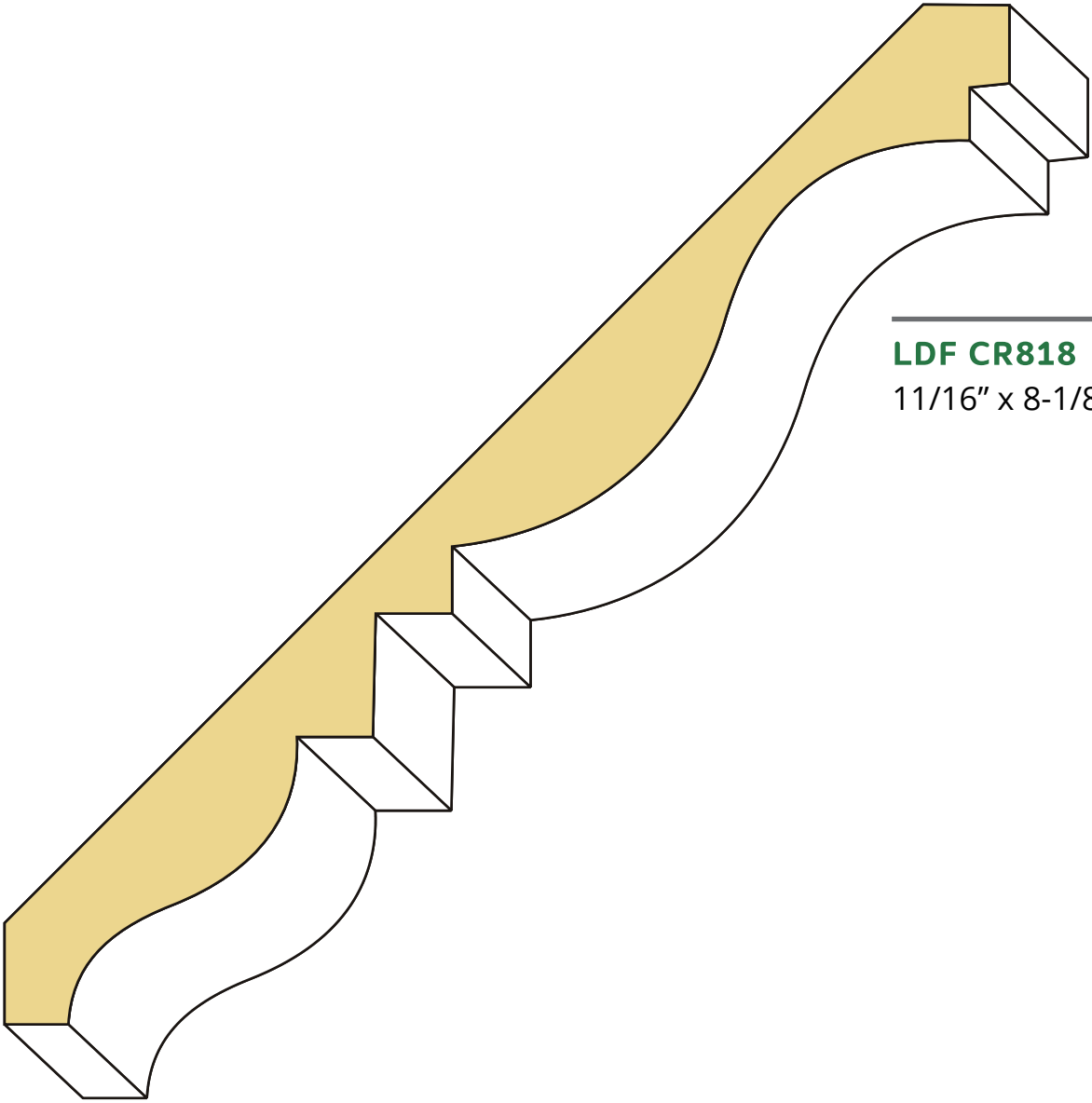

LDF CR818
1 1/16" x 8-1/8"

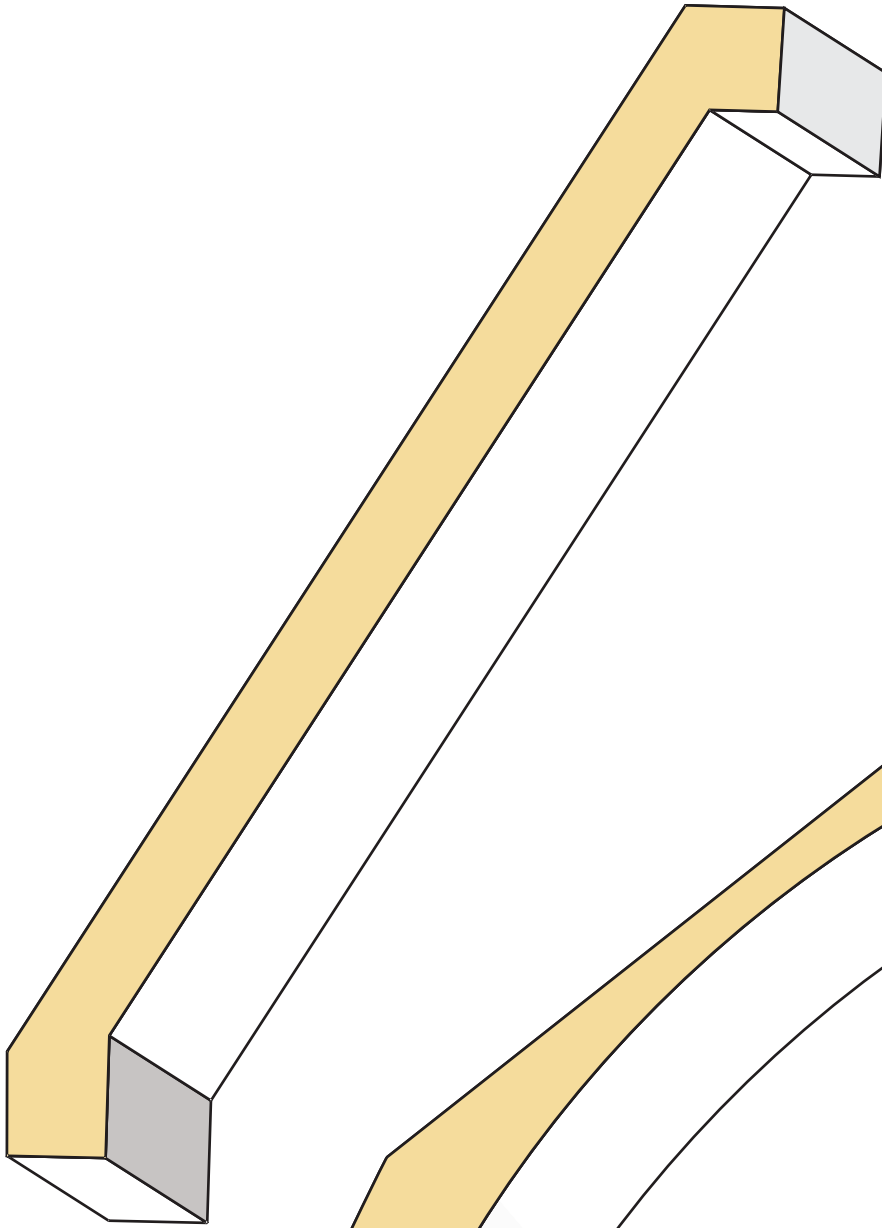

LDF CR714C
3/4" x 7-1/4"

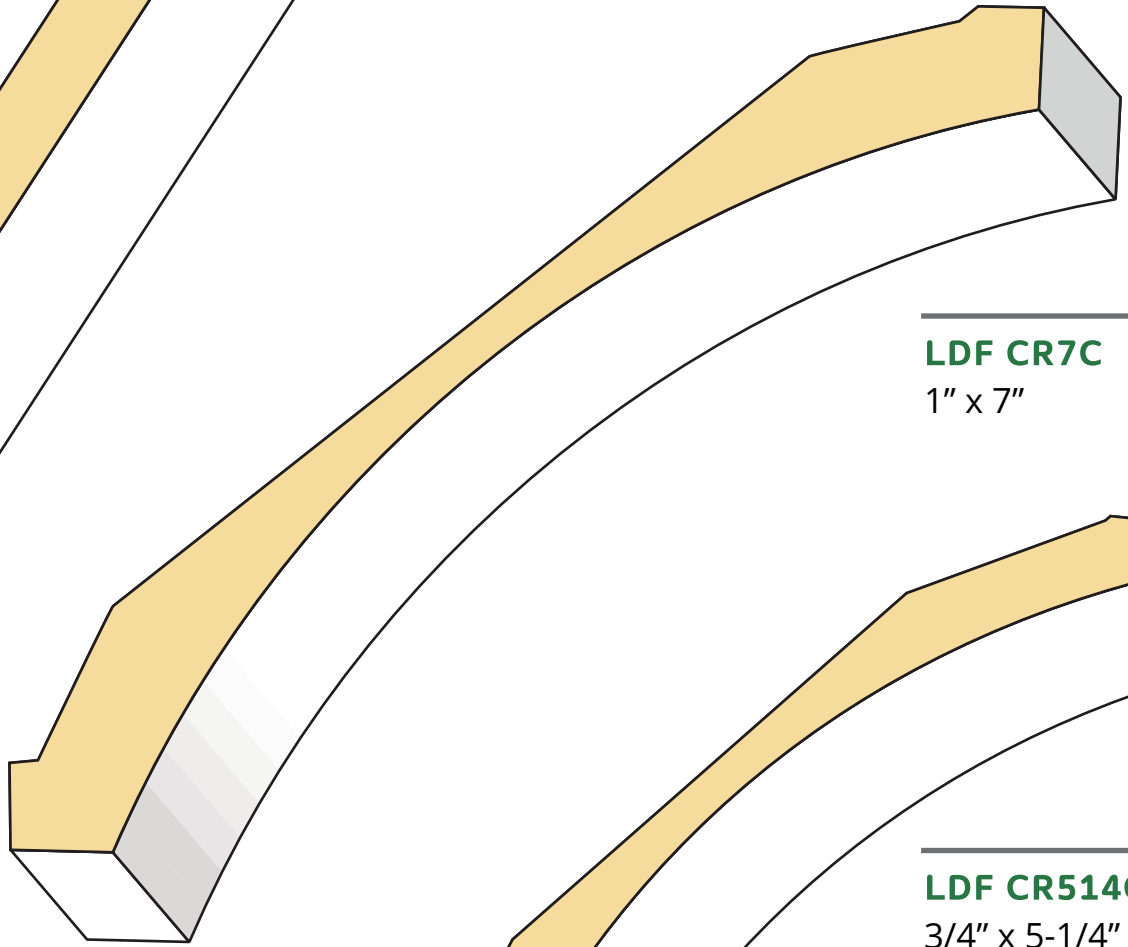

LDF CR7C
1" x 7"

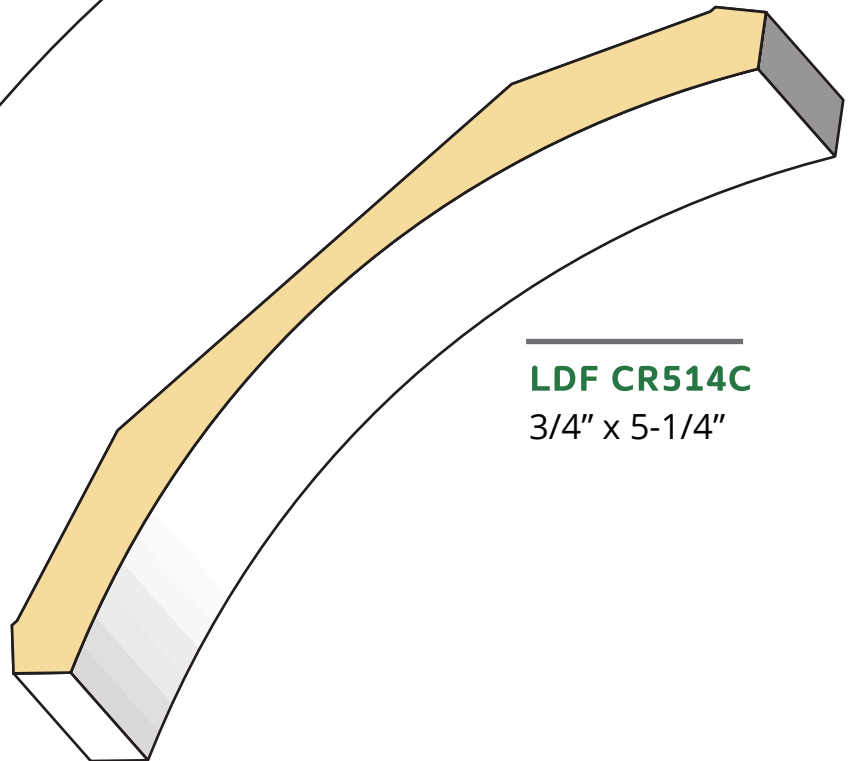

LDF CR514C
3/4" x 5-1/4"

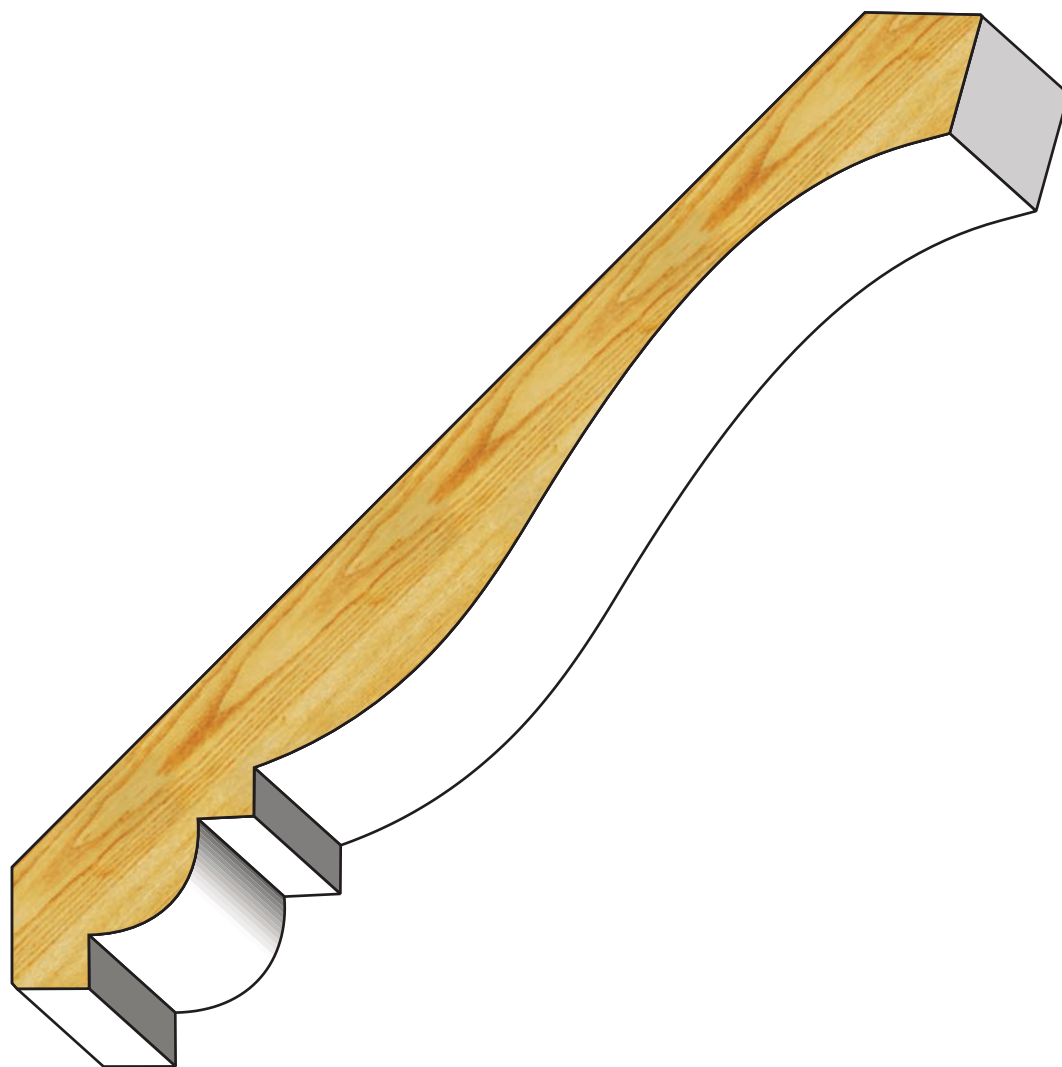

CR 718PP
3/4" x 7-1/8"

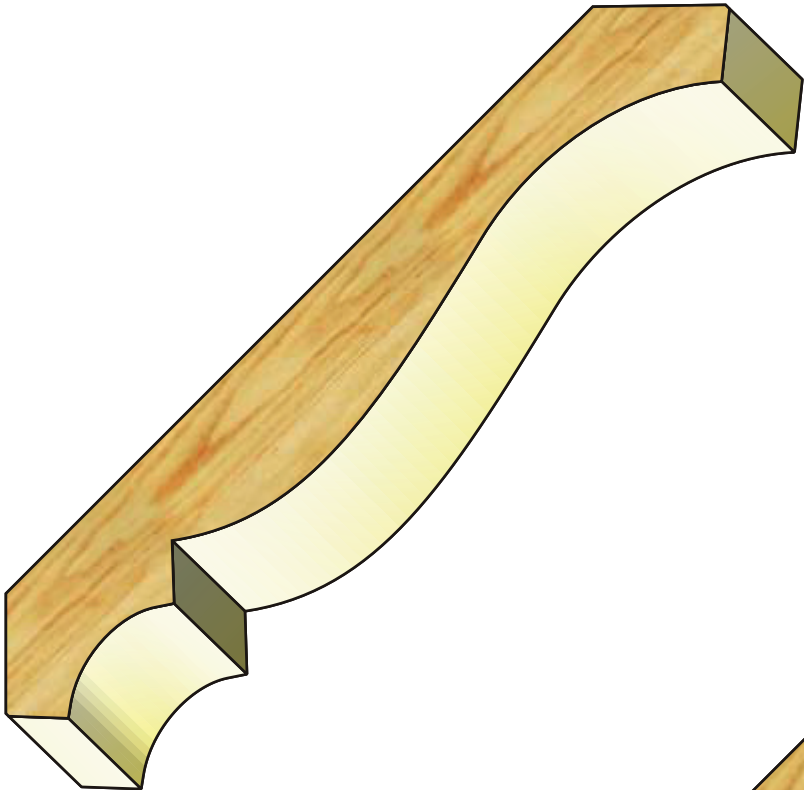

CR 514
3/4" x 5-1/4"

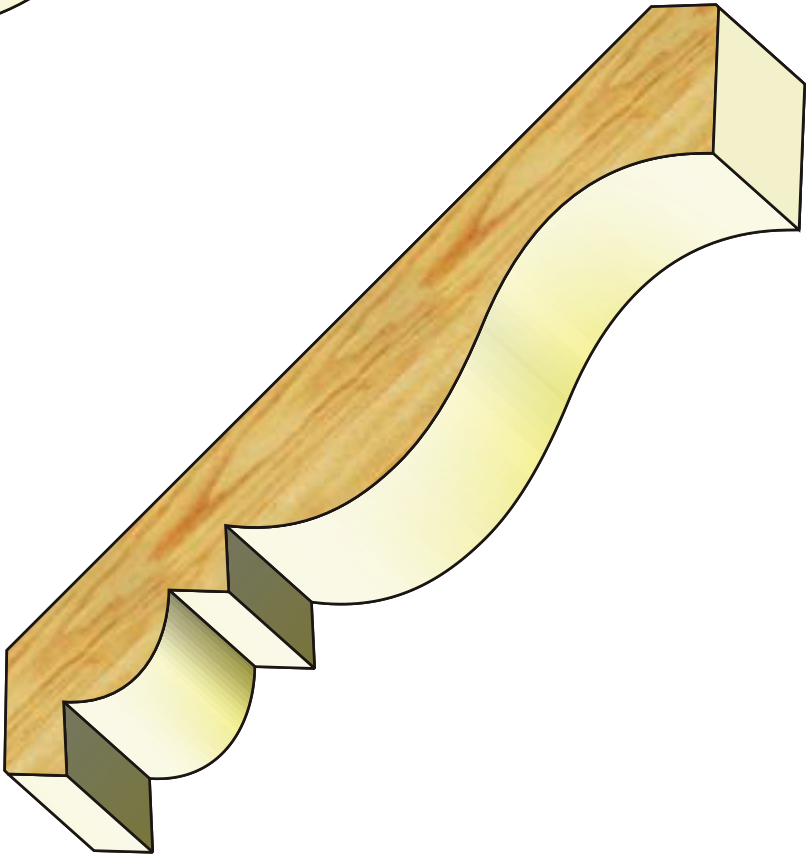

CR 512A
3/4" x 5-1/2"

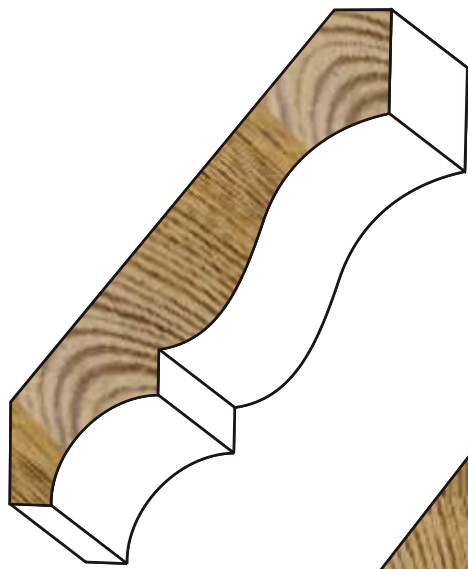

51
9/16" x 3-1/4"

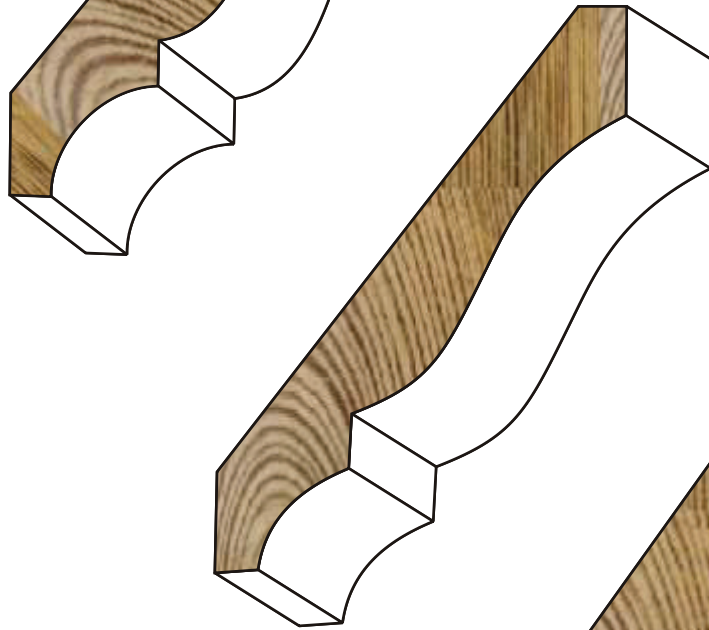

49
9/16" x 3-5/8"

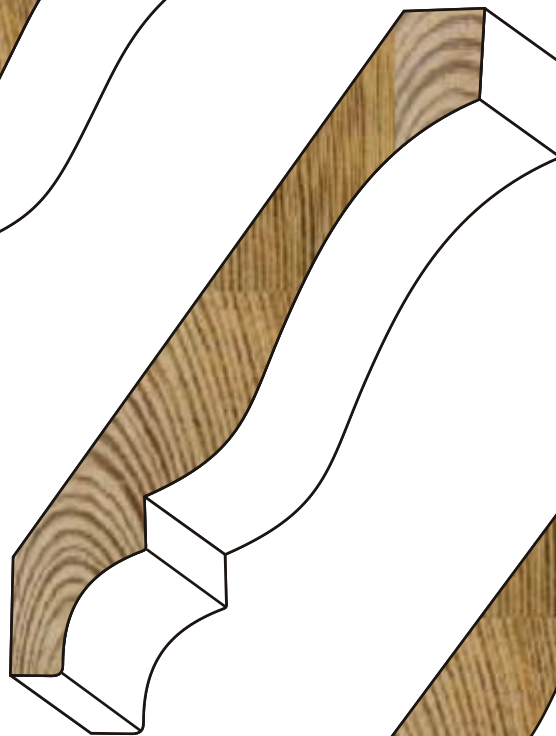

48
9/16" x 4-1/4"

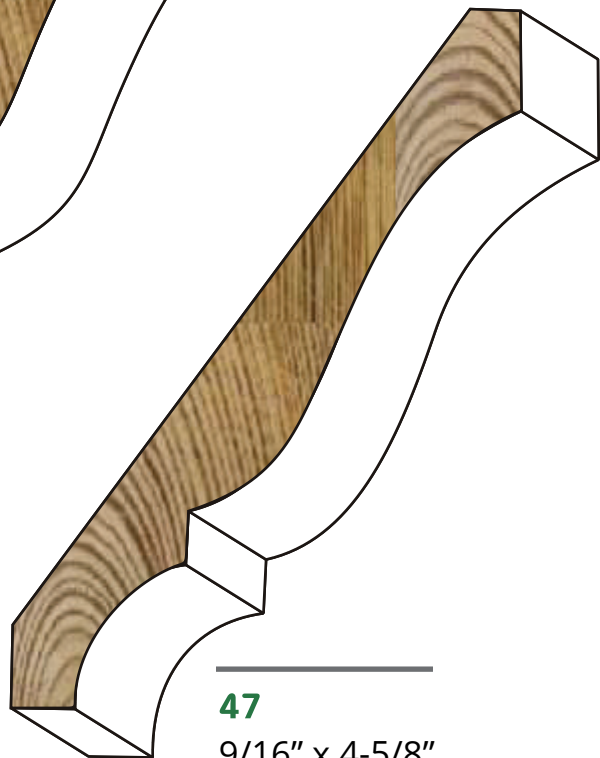

47
9/16" x 4-5/8"

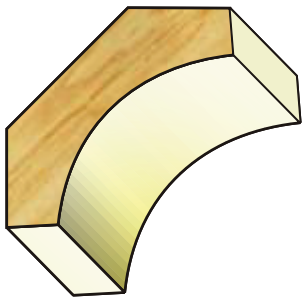

86
9/16" x 1-5/8"
Solid White Pine
Random Length
Only

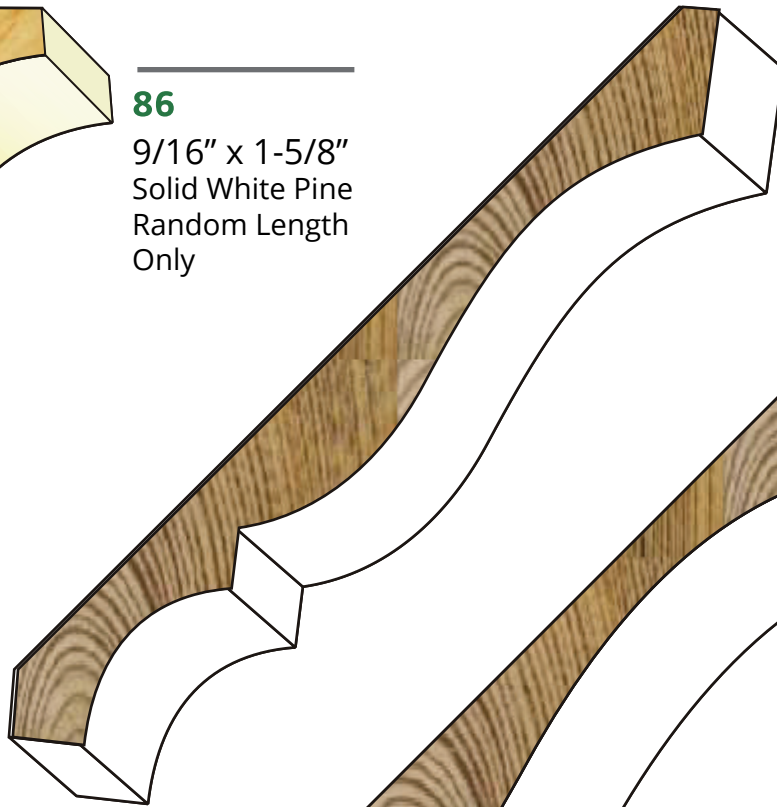

45
11/16" x 5-1/4"

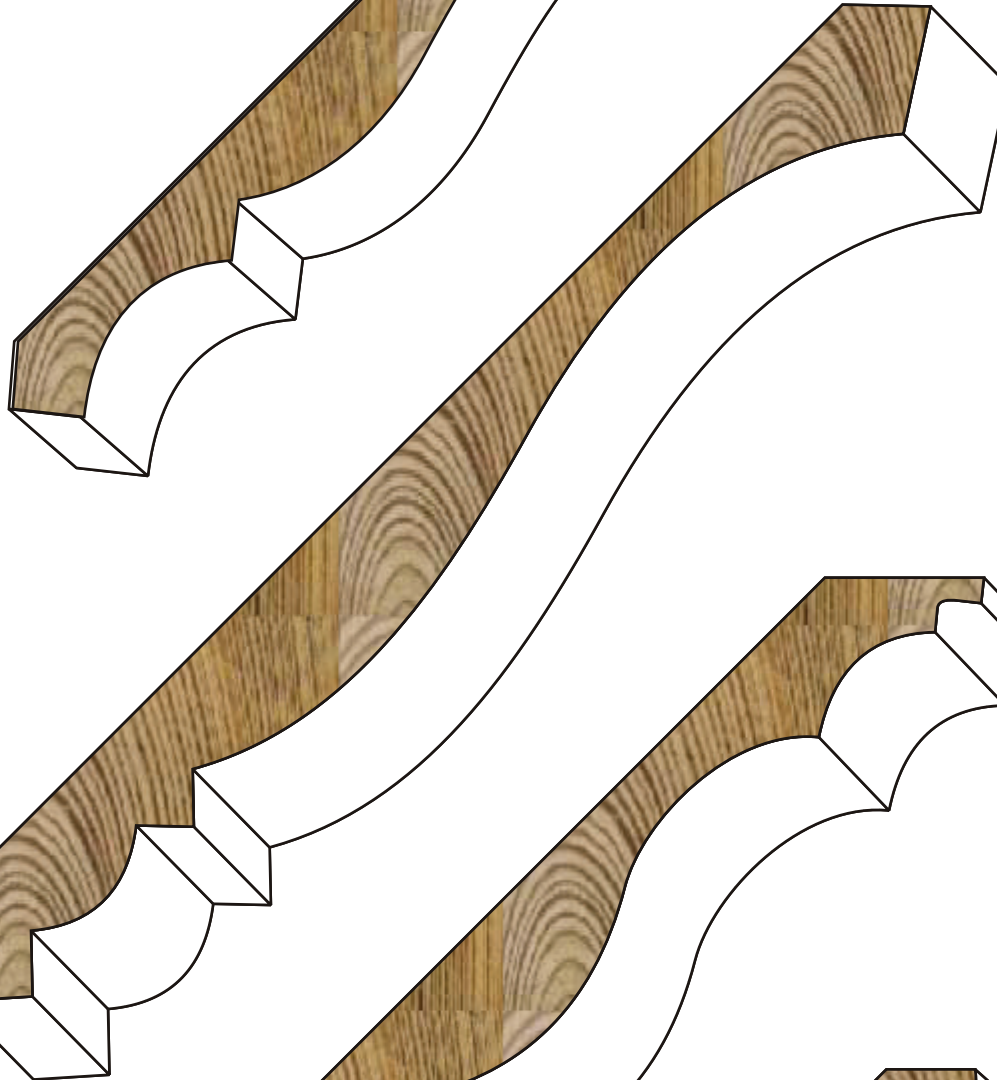

714
11/16" x 7-1/4"

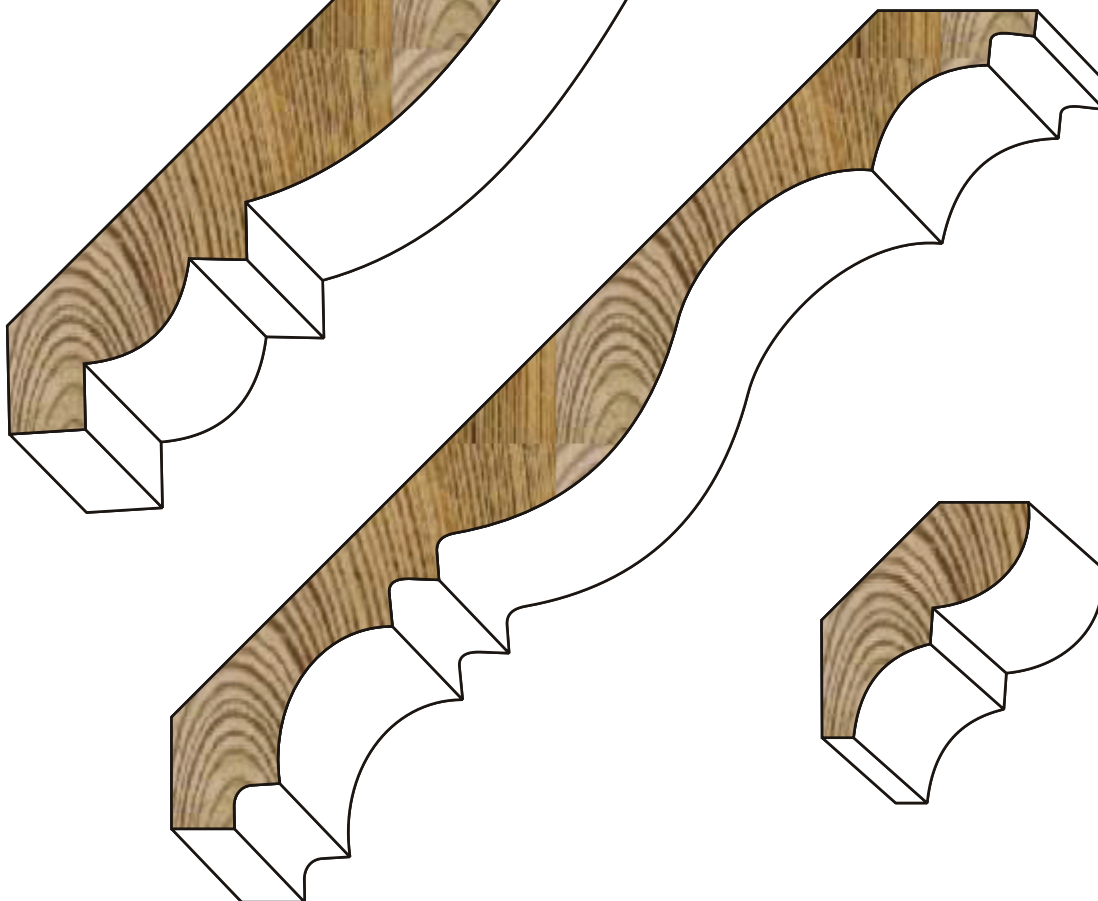

614
11/16" x 6-1/4"

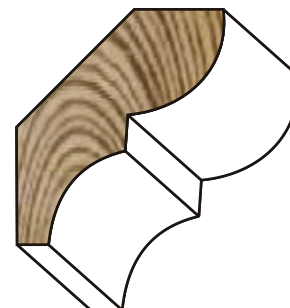

75
9/16" x 1-5/8"



212C
3/4" x 1-7/8"
Select Cypress



CR 514C
3/4" x 5-1/4"
Select Cypress

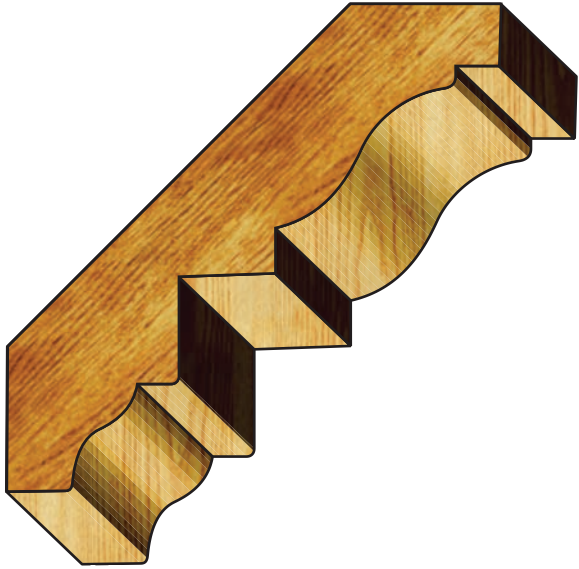

CR 358HM
3/4" x 3-5/8"

Stock Chair Rails

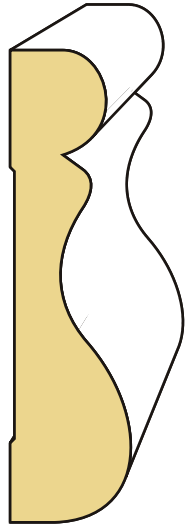

LDF 914
 5/8" x 2-7/16"
 Base Cap

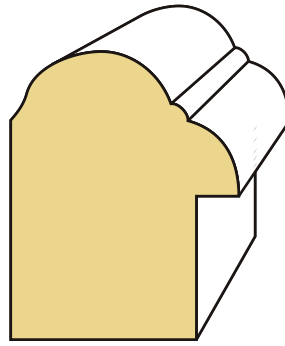

w/ 1/4" X 3/4" Rabbet
LDF BB112
 1-3/16" x 1-1/2"
 Back Band

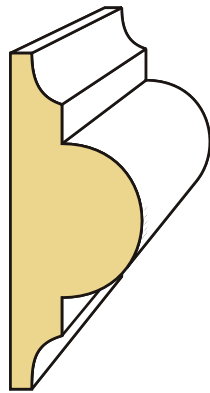

LDF AM134B
 3/4" x 1-3/4"
 Applied Moulding

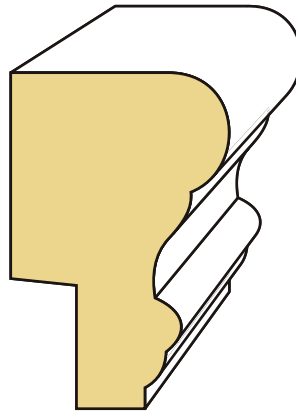

w/ 3/8" x 11/16" Rabbet
LDF 850M
 1-1/8" x 1-3/4"
 Wainscot Cap



CH 312BPP

1-1/16" x 3-1/2"

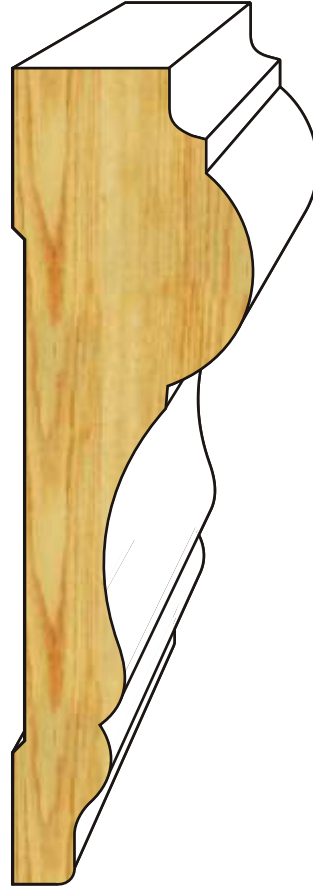

CH 414PP

1-1/4" x 4-1/4"



CH 314
11/16" x 3-1/4"

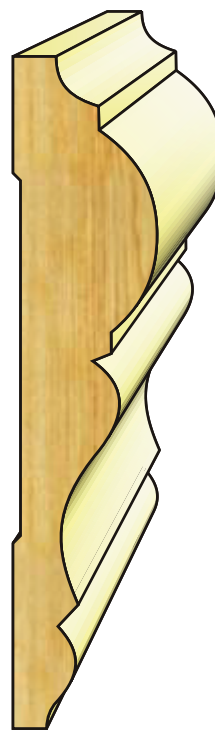

CH 312
3/4" x 3-1/2"

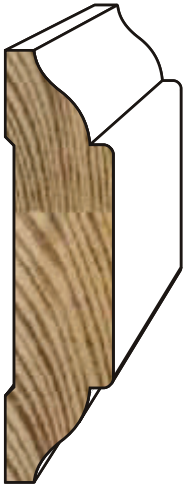

224
9/16" x 2-1/4"

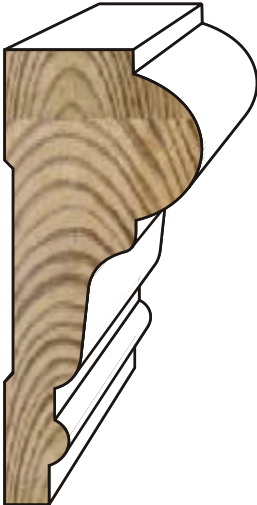

392
1-1/16" x 2-3/8"



390
11/16" x 2-5/8"



300
1-1/16" x 3"

*Stock S-4-S
Surfaced
4 Sides*

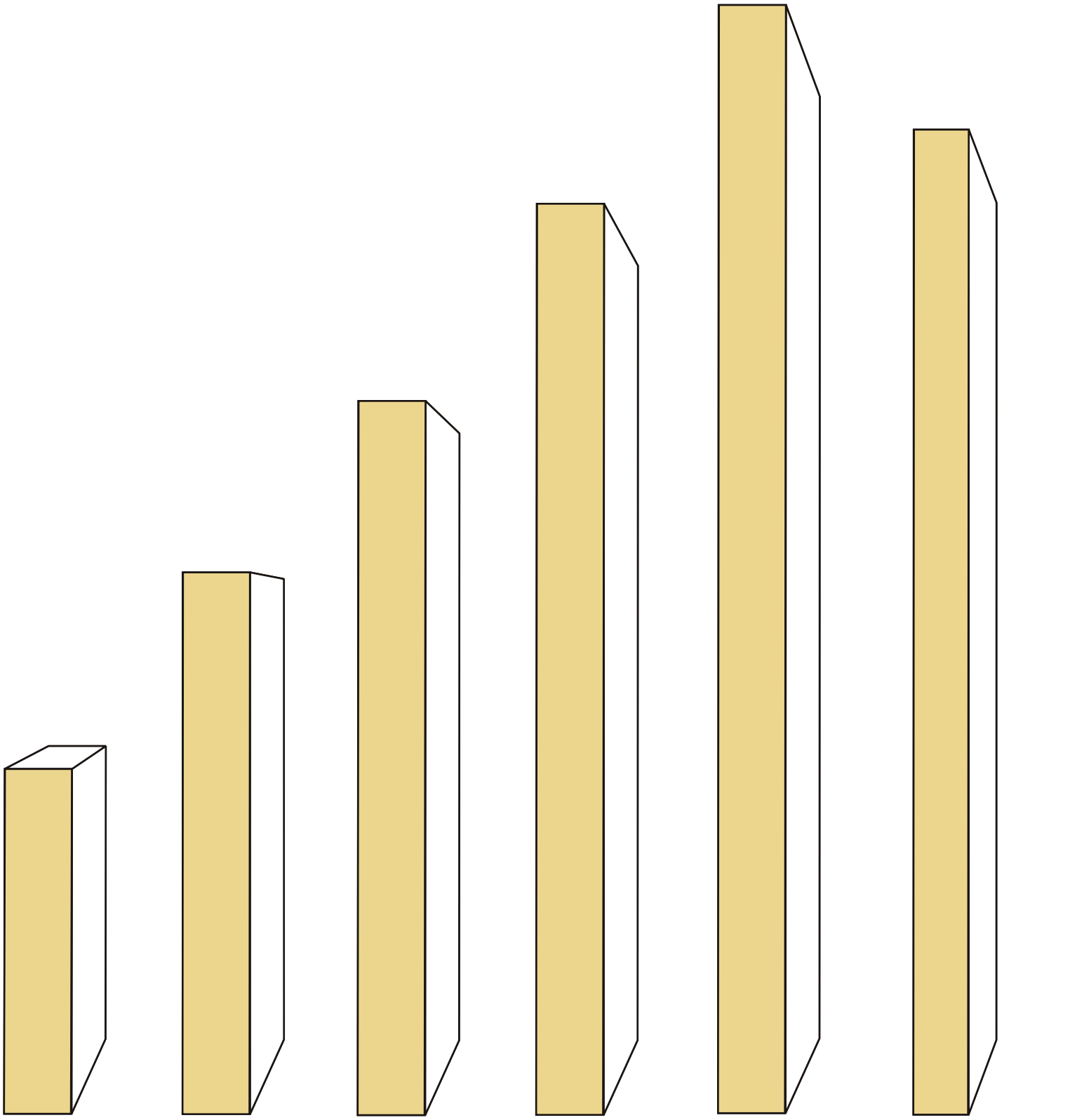

14 LDF

11/16" x 3-1/2"

Available 17'

16 LDF

11/16" x 5-1/2"

18 LDF

11/16" x 7-1/4"

110 LDF

11/16" x 9-1/4"

112 LDF

11/16" x 11-1/4"

LDF 901

9/16" x 10"

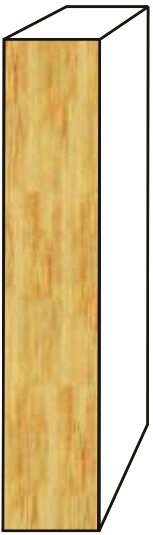

14 PP12
14 PP17
3/4" x 3-1/2"
Available 17'



16 PP12
16 PP 16
3/4" x 5-1/2"



18 PP12
18 PP 16
3/4" x 7-1/4"



110 PP12
110 PP 16
3/4" x 9-1/4"

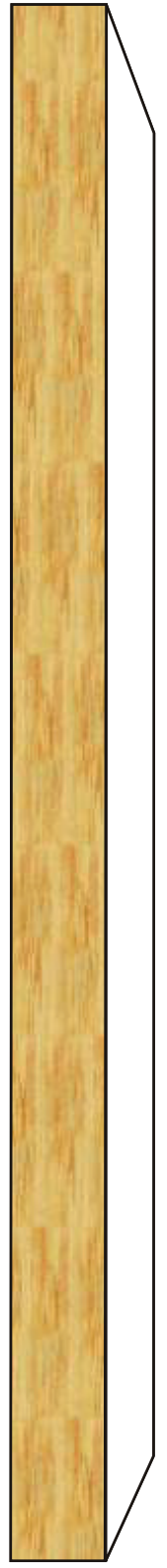

112 PP12
112 PP 16
3/4" x 11-1/4"

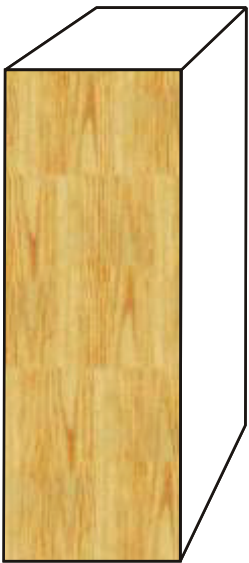

444 PP 17
1" x 3-1/2"
Available 17'



446 PP12
446 PP16
1" x 5-1/2"



448 PP12
448 PP16
1" x 7-1/4"



546 PP12
546 PP16
1-1/4" x 5-1/2"



548 PP12
548 PP16
1-1/4" x 7-1/4"

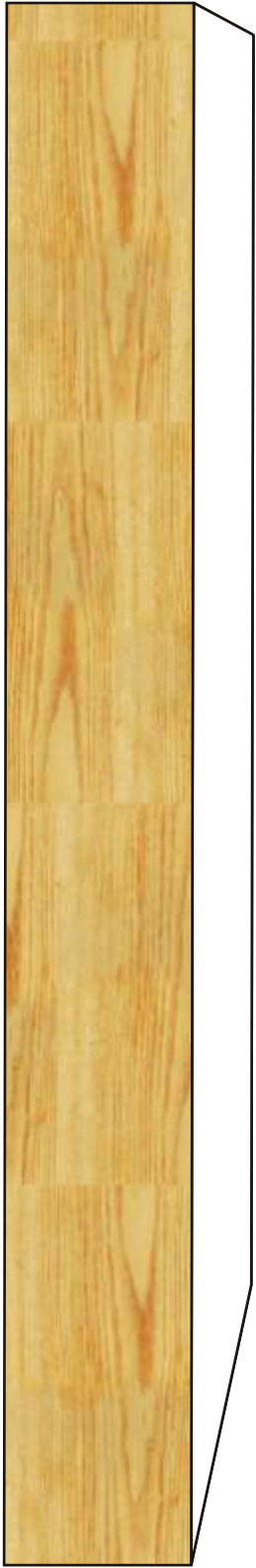

5412 PP12
5412 PP16
1-1/4" x 11-1/4"



26 PP12
26 PP16
1-1/2" x 5-1/2"



28 PP12
28 PP16
1-1/2" x 7-1/4"



212 PP12
212 PP16
1-1/2" x 11-1/4"



14 P
3/4" x 3-1/2"



16 P
3/4" x 5-1/2"



18 P
3/4" x 7-1/4"



110 P
3/4" x 9-1/4"

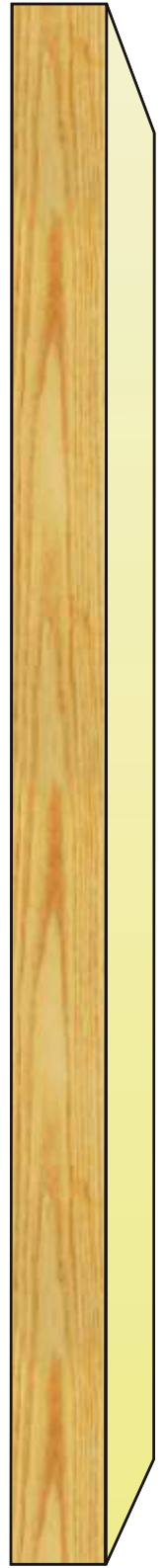

112 P
3/4" x 11-1/4"



1412 P
1/4" x 11-1/4"



3812 P
3/8" x 11-1/4"



1212 P
1/2" x 11-1/4"



546 P
1-1/4" x 5-1/2"

548 P
1-1/4" x 7-1/4"



212 P
1-1/2" x 11-1/4"



12 FJ
21/32" x 1-1/2"
16' Lengths



13 FJ
21/32" x 2-1/2"
17' Lengths



14 FJ
21/32" x 3-1/2"
17' Lengths



16 FJ
21/32" x 5-1/2"



18 FJ
21/32" x 7-1/4"

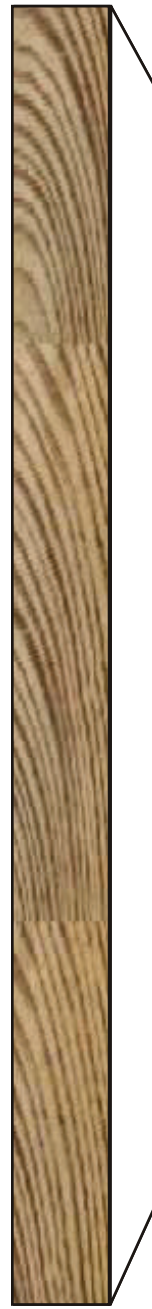

110 FJ
21/32" x 9-1/4"



112 FJ
21/32" x 11-1/4"



16 SCANT
9/16" x 5-1/2"



18 SCANT
9/16" x 7-1/4"



16 RO
3/4" x 5-1/2"



18 RO
3/4" x 7-1/4"



112 RO
3/4" x 11-1/4"



16 HM
3/4" x 5-1/2"
Hard Maple



18 HM
3/4" x 7-1/4"
Hard Maple



16 M
3/4" x 5-1/2"
Sapele Mahogany



14 SC
3/4" x 3-1/2"



16 SC
3/4" x 5-1/2"



18 SC
3/4" x 7-1/4"



110 SC
3/4" x 9-1/4"

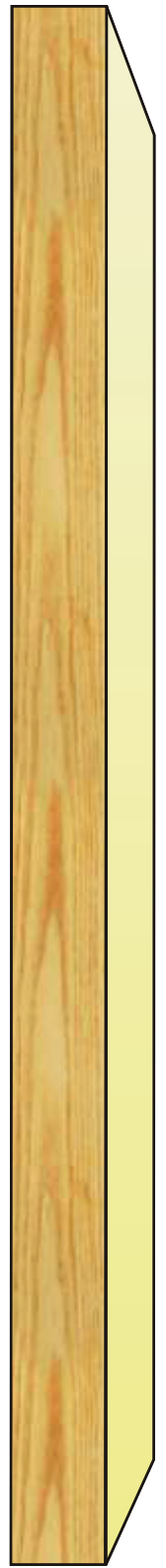

112 SC
3/4" x 11-1/4"

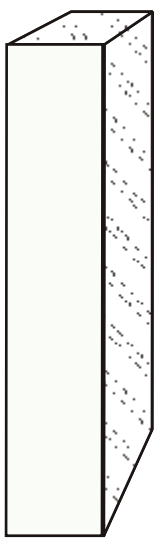

14 PVC
3/4" x 3-1/2"

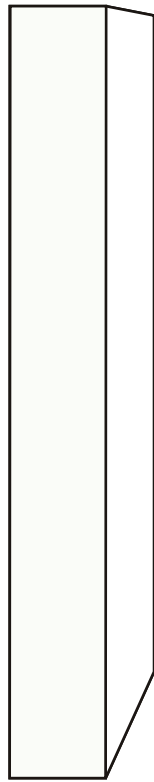

16 PVC
3/4" x 5-1/2"



18 PVC
3/4" x 7-1/4"

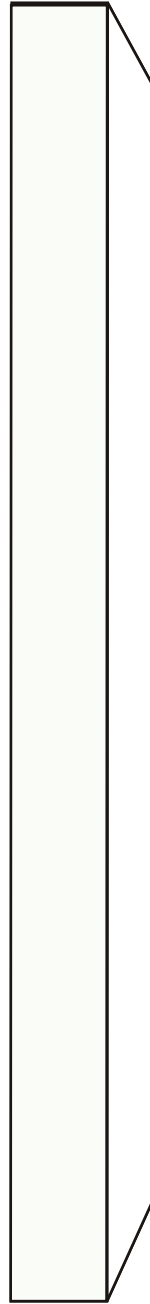

110 PVC
3/4" x 9-1/4"

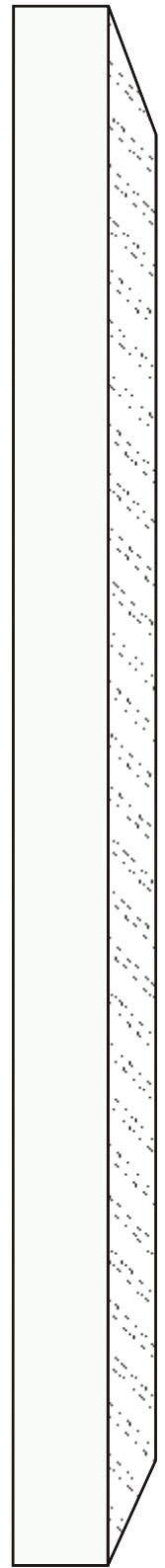

112 PVC
3/4" x 11-1/4"

Stock T&G
Misc.

Primed LDF
V-Joint Thin
Ship Lap

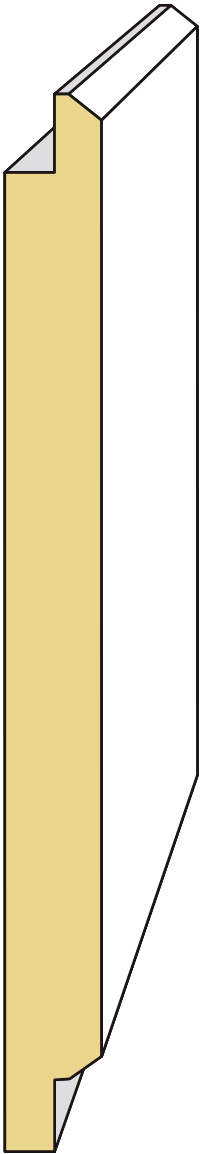

LDF 16 VJ
1/2" x 5-1/2"

Primed LDF
V-Joint Thick

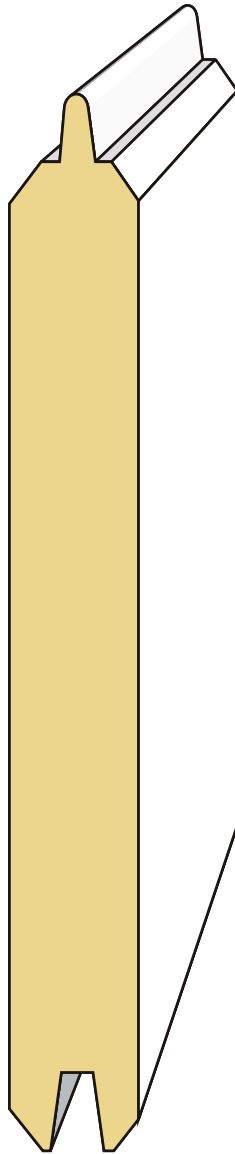

LDF 16 VJA
11/16" x 5-1/2"

Primed FJ WP
V-Joint



16 TGVJ PFJ
11/16" x 5-1/2"

SY PINE
V-Joint



16 SYPTGVJ
3/4" x 5-1/2"

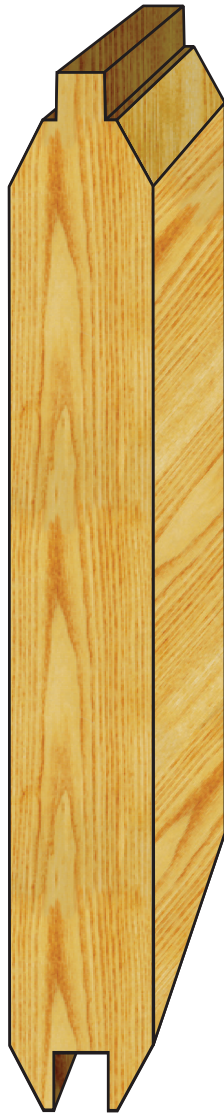

16 C TG
3/4" x 5-1/2"
Select Cypress



16 2C TGVJ
3/4" x 5-1/2"
#2 Cypress

Nickel Gap

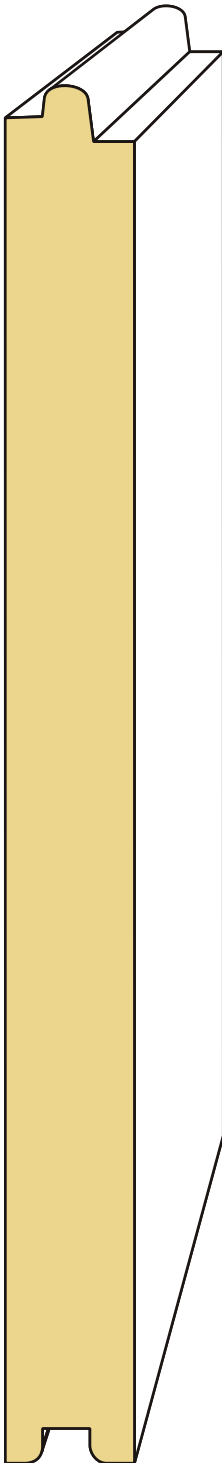

LDF 18 NGA
11/16" x 7-1/4"

Nickel Gap

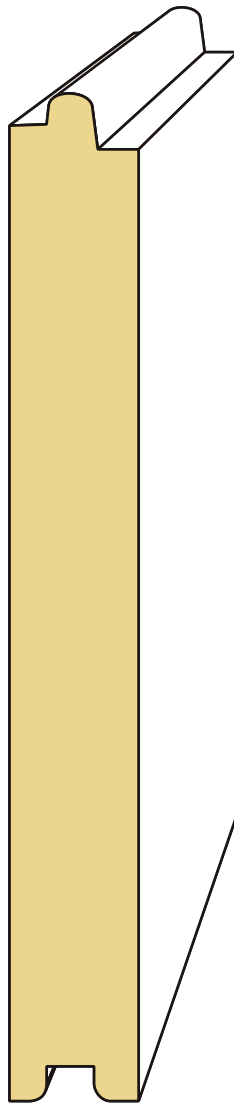

LDF 16 NGA
11/16" x 5-1/4"

Nickel Gap

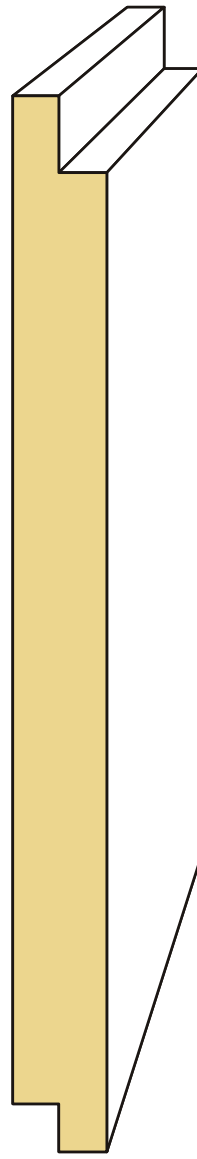

LDF 16 NG
1/2" x 5-1/2"

Center Bead

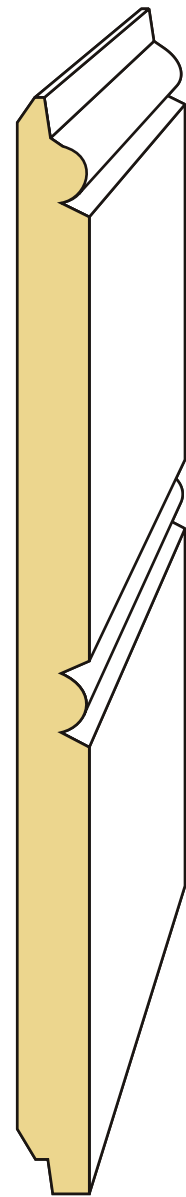

LDF 16 CB
3/8" x 5-3/4"

Nickel Gap
FJWP



18 FJ NG
5/8" x 7-1/4"
Length 16'

Nickel Gap
FJWP



16 FJ NG
5/8" x 5-1/8"
Length 16'

Nickel Gap
#2 Cypress



162 CNG
3/4" x 5-1/2"
#2 Cypress

Nickel Gap
Select Cypress



16 CNG
3/4" x 5-1/2"
Select Cypress

Nickel Gap
Fir



16 NGF
11/16" x 5-1/4"
Un-primed C-Fir

Nickel Gap
SYP



16 SYPTGNG
3/4" x 5-1/2"



WS 6PP
3/4" x 5-1/2"



WS 7PP
3/4" x 7-1/4"



WS 8PP
1-1/16" x 8"

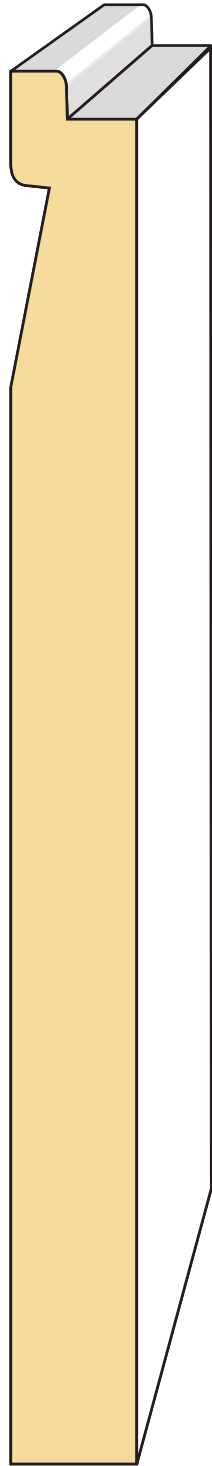

LDF 714WE
11/16" x 7-1/4"

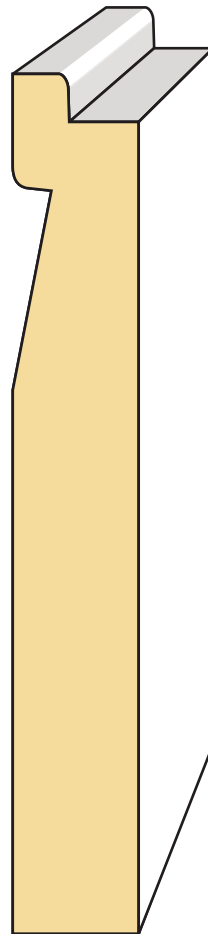

LDF 412WE
11/16" x 4-1/2"

AC PLYWOOD

34 AC P 3/4" x 4' x 8'

BENDING PLY

38 BP C 3/8" x 4' x 8' - Column

38 BP T 3/8" x 4' x 8' - Barrell

BIRCH G1 S

14 B P 1/4" x 4' x 8'

12 B P 1/2" x 4' x 8'

34 B P 3/4" x 4' x 8'

WHITE MAPLE

14 WM P 1/4" x 4' x 8' C-4

12 WM P 1/2" x 4' x 8' B-2

34 WM P 3/4" x 4' x 8' B-2

MDF MEDIUM DENSITY FIBER

14 MDF P 1/4" x 4' x 8'

12 MDF P 1/2" x 4' x 8'

34 MDF P 3/4" x 4' x 8'

3410 MDFP 3/4" x 4' x 10'

PINE FACE BEAD BOARD

38 BB P 3/8" x 4' x 8'

PRIMED WP FG BRICK MOULD

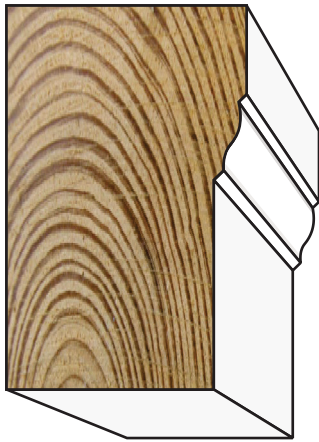

**180 PRIMED
FJ WP**
1-1/4" x 2"
Length 17'



**176L PRIMED
FJ WP**
11/16" x 1-5/8"
Length 17'

PVC BRICK MOULD - SMOOTH & TEXTURED

17' LENGTHS

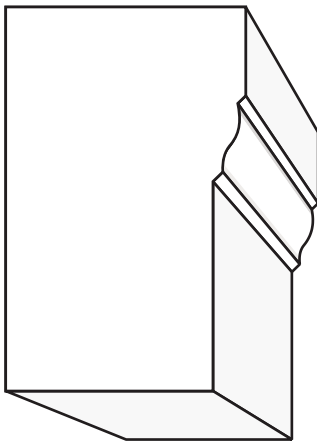

**18017 SPVC
18017 TPVC**
1-1/4" x 2"

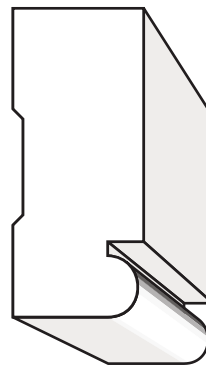

**176S PVC
176T PVC**
11/16" x 1-5/8"

**PVC QUARTER ROUND
AVAILABLE LENGTH 8' ONLY**

**PVC
LATTICE**

**SAPELE MAHOGANY BRICK MOULD
AVAILABLE LENGTHS 8' ONLY**

**PVC GLASS
STOP**



QRPVC 8
5/16" x 9/16"
SMOOTH 8'-6"

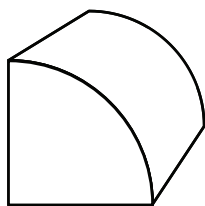

105 PVC
3/4" x 3/4"
SMOOTH



266 8 PVC
1/4" x 1-1/2"
SMOOTH 8' LENGTH



180 M
1-1/4" x 2"



887312 PP
1/2" x 3-1/2"



887212 PP
1/2" x 2-1/2"

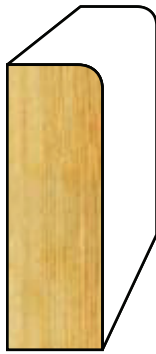

887 PP
1/2" x 1-1/2"

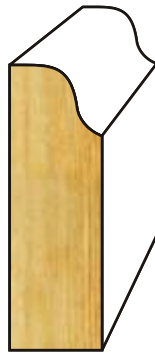

916 PP
1/2" x 1-1/2"



916212 PP
1/2" x 2-1/2"

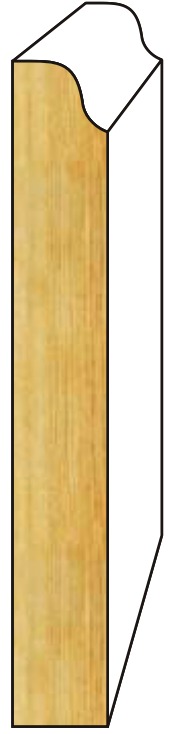

916312 PP
1/2" x 3-1/2"

UNPRIMED SOLID POPLAR DOOR STOP

AVAILABLE LENGTHS 8' TO 16'

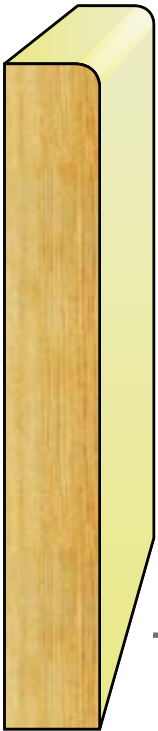

887312P
1/2" x 3-1/2"



887P
1/2" x 1-1/2"

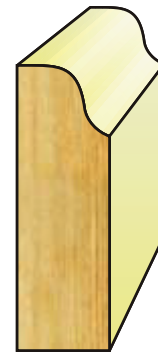

916P
1/2" x 1-1/2"

PRIMED FJ WP DOOR STOP & SHOE MOULD



887 L
3/8" x 1-1/4"
Length 17'

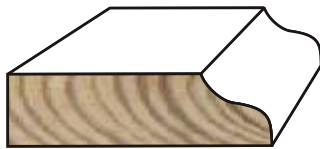

916 L
3/8" x 1-3/8"
Length 17'



856 L
3/8" x 1-3/8"
Length 17'



129
7/16" x 11/16"
Length 16'

PRIMED FJ WP COVE & QTR ROUND

16' LENGTHS



100
11/16" x 11/16"



106
3/4" x 3/4"

Also see Solid Clear White Pine - Page 76

T-ASTRAGAL

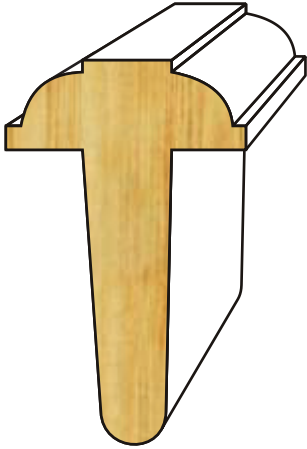

T 1388 PP

1-3/8" Door x 9' Lengths
Primed FJ Poplar

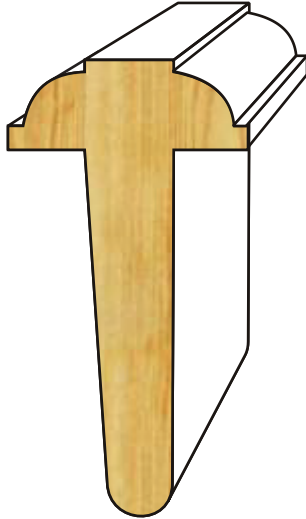

T 1348 PP

1-3/4" Door x 9' Lengths
Primed FJ Poplar

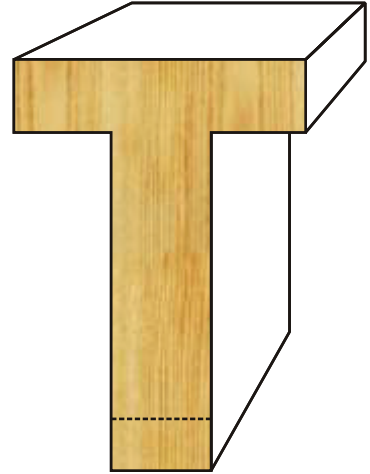

T 134F PP

1-3/4" Door x 9' Flat
1-3/8" Door x 9' Flat
Primed FJ Poplar

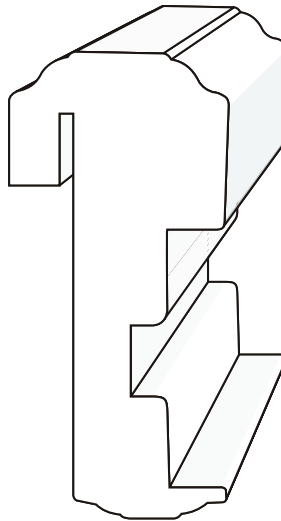

T 1348KS PVC

PVC Exterior
1-3/4" Door x 8' Lengths

PRIMED FJ POPLAR BASE CAP

17' LENGTHS

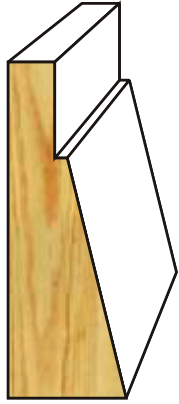

BC 8BPP

5/8" x 1-3/4"

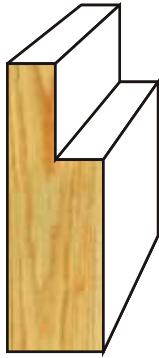

BC 8APP

1/2" x 1-1/2"

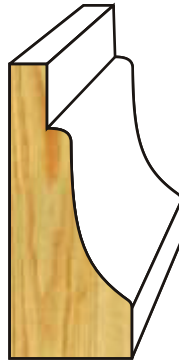

BC 8FPP

5/8" x 1-1/2"

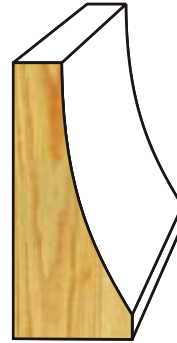

BC 818PP

5/8" x 1-7/16"

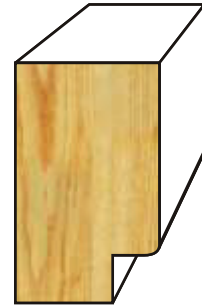

BC 714NPP

3/4" x 1-1/4"

PRIMED FJ POPLAR BASE CAP

16' LENGTHS



163

11/16" x 1-3/8"

PRIMED FJ POPLAR BASE CAP

17' LENGTHS

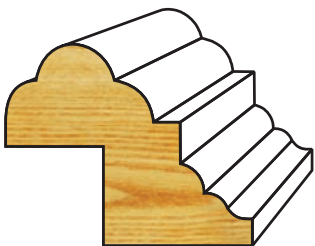

PM 114PP

1" x 1-1/4"
w/ 1/2" x 1/2" Rabbet

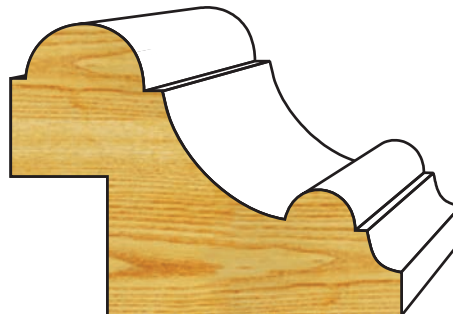

PM 2PP

1-1/2" x 2"
w/ 1/2" x 11/16" Rabbet

POPLAR ROPE MOULDING

8' LENGTHS



RP34

5/16" x 3/4"

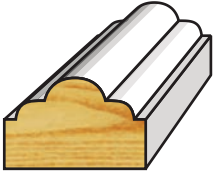

AM 34PP
1/2" x 3/4"



AM 78PP
1/2" x 7/8"

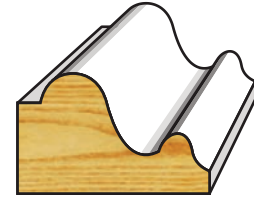

AM 1PP
5/8" x 1"

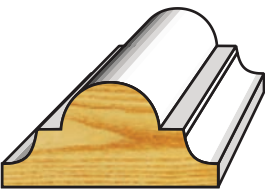

AM 118PP
9/16" x 1-1/8"



AM 114PP
9/16" x 1-1/4"

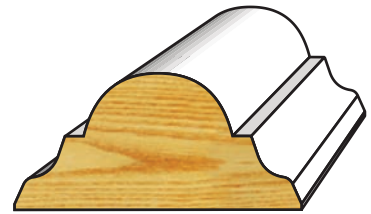

AM 112PP
3/4" x 1-1/2"

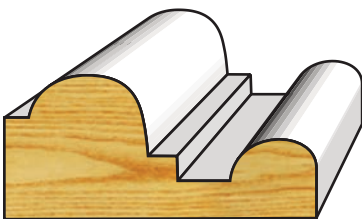

AM 158PP
3/4" x 1-5/8"

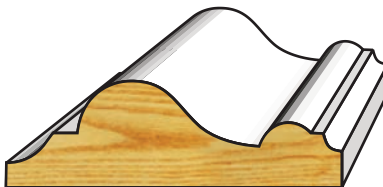

AM 134PP
9/16" x 1-3/4"



AM 134APP
11/16" x 1-3/4"

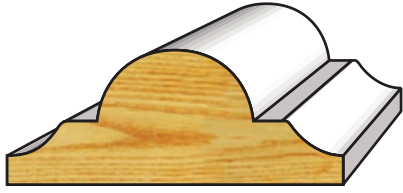

AM 134BPP

3/4" x 1-3/4"

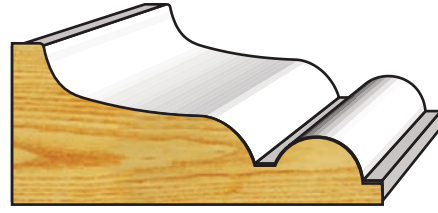

AM 11516PP

13/16" x 1-15/16"



AM 2PP

3/4" x 2"



AM 218PP

9/16" x 2-1/8"



AM 214PP

13/16" x 2-1/4"

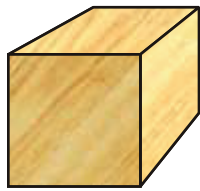

239
11/16" x 11/16"

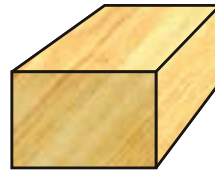

254
1/2" x 3/4"

OUTSIDE CORNER

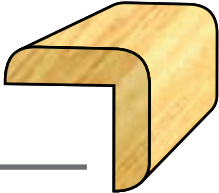

206
3/4" x 3/4"

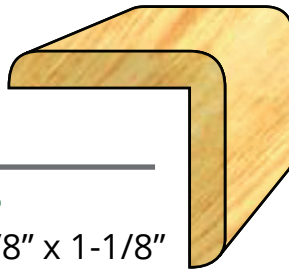

205
1-1/8" x 1-1/8"

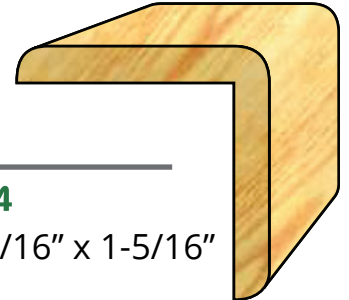

204
1-5/16" x 1-5/16"

S4S PINE LATTICE



268
1/4" x 1-1/8"



267
1/4" x 1-3/8"



266
1/4" x 1-1/2"

QTR ROUND



110
1/4" x 1/4"



108
1/2" x 1/2"

HALF ROUND

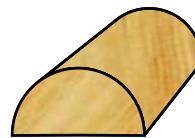

122
3/4" x 8'

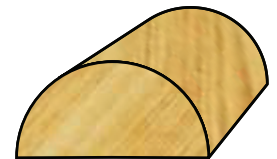

120
1"

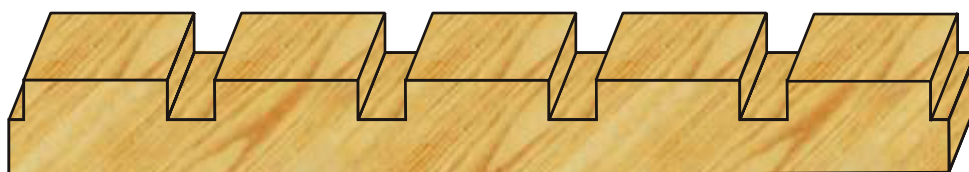

DENTIL MOULD

1/2" x 5/8" x 8'

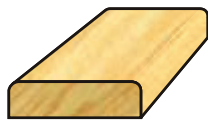

142
3/16" x 3/4"

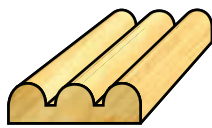

144
3/16" x 3/4"



OVOLO
3/8" x 5/8"



281 BACK BAND
11/16" x 1-1/8"



987
3/8" x 2" x 8'

MULLION

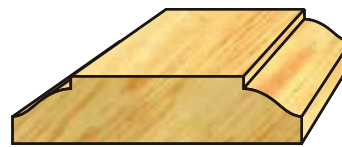

988
3/8" x 1-1/2" x 8'

ROSETTE



ROSE 212 BULLS EYE
2-1/2" x 2-1/2" x 1"

ROSE 334 BULLS EYE
3-3/4" x 3-3/4" x 1-1/8"

ROSE 414 BULLS EYE
4-1/4" x 4-1/4" x 1-5/16"

PLINTH 2126
2-1/2" x 6" x 1"

PLINTH 3346
3-3/4" x 6" x 1-1/8"

PLINTH 3348
3-3/4" x 8" x 1-1/8"



PLINTH BLOCK



PLINTH 33412
3-3/4" x 12" x 1-1/8"

PLINTH 4148
4-1/4" x 8" x 1-5/16"

PLINTH 41412
4-1/4" x 12" x 1-5/16"

SOLID CLEAR WHITE PINE DECRA MOULDING

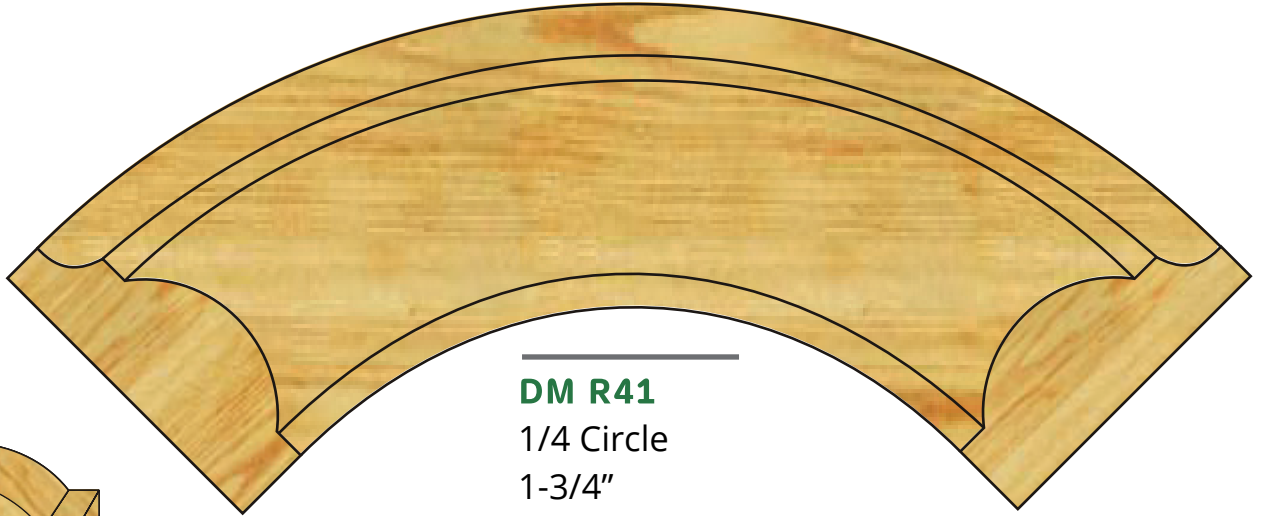

DM R41
1/4 Circle
1-3/4"

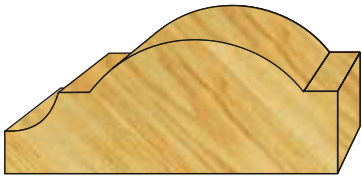

DM R42
11/16" x 1-3/4"
8' Lengths

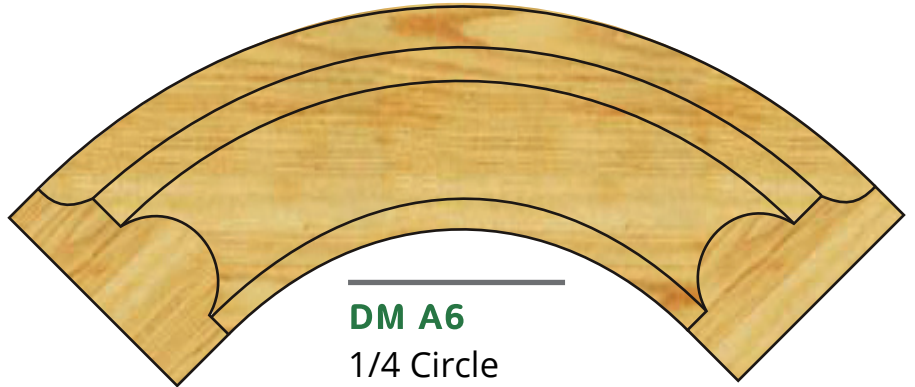

DM A6
1/4 Circle
1-1/4"

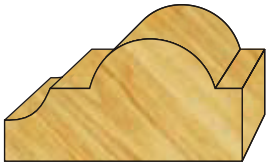

DM A9
3/4" x 1-1/4"
8' Lengths



DM D4
1/4 Circle
7/8"



DM D7
5/16" x 7/8"
8' Lengths



DM L58
3/16" x 1/2"
8' Lengths



DM L51
1/4 Circle
1/2"

STYLES

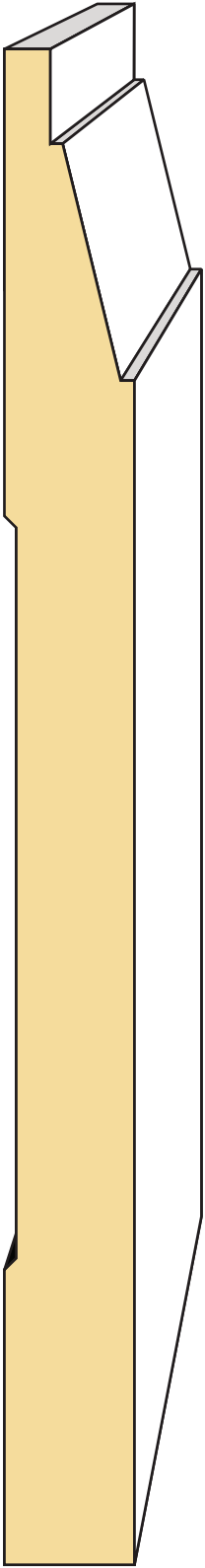

LDF BA8B
1 1/16" x 8"

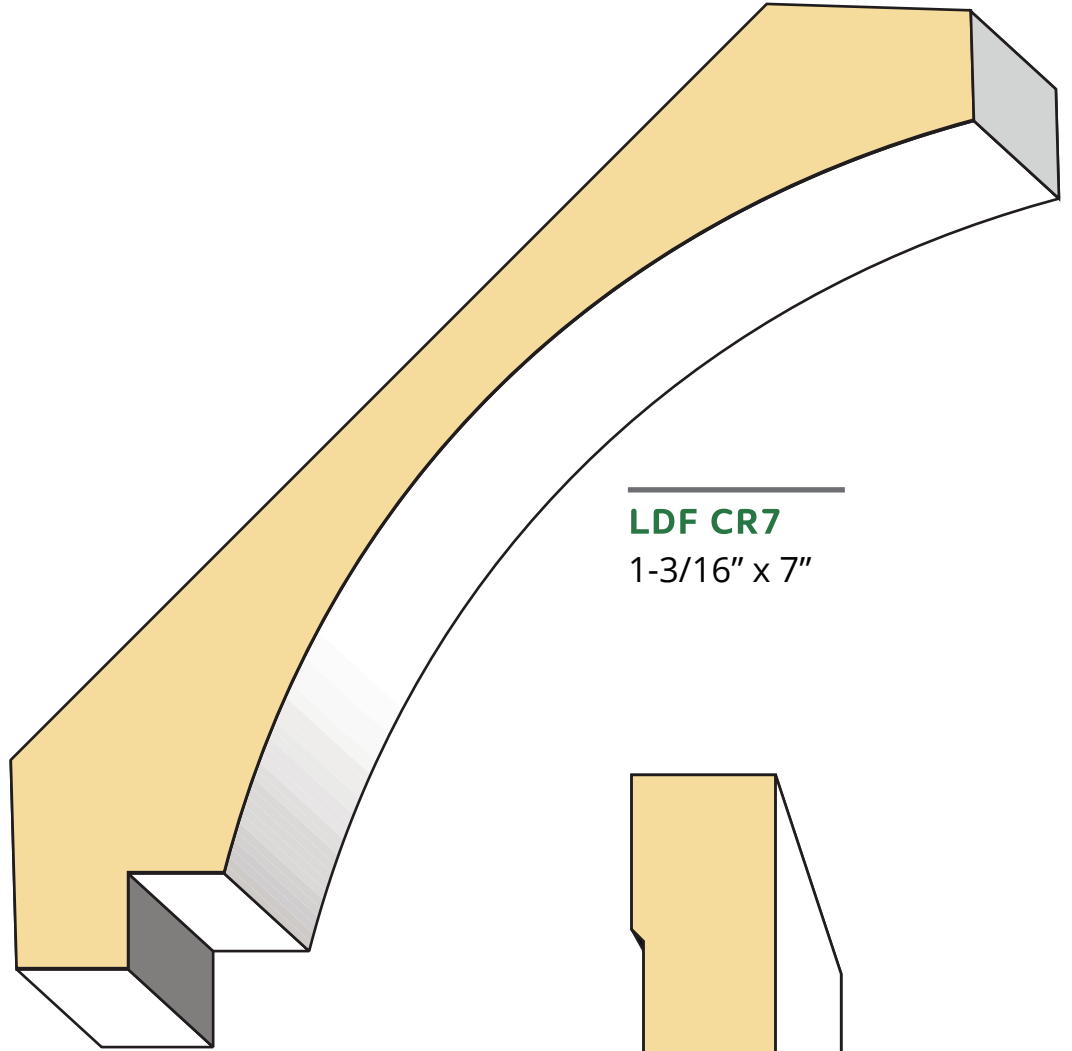

LDF CR7
1-3/16" x 7"

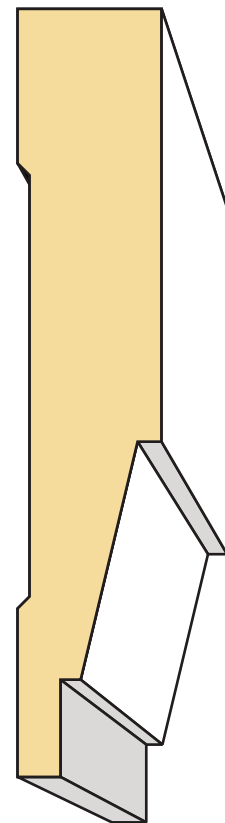

LDF CA4D
1 3/16" x 4"

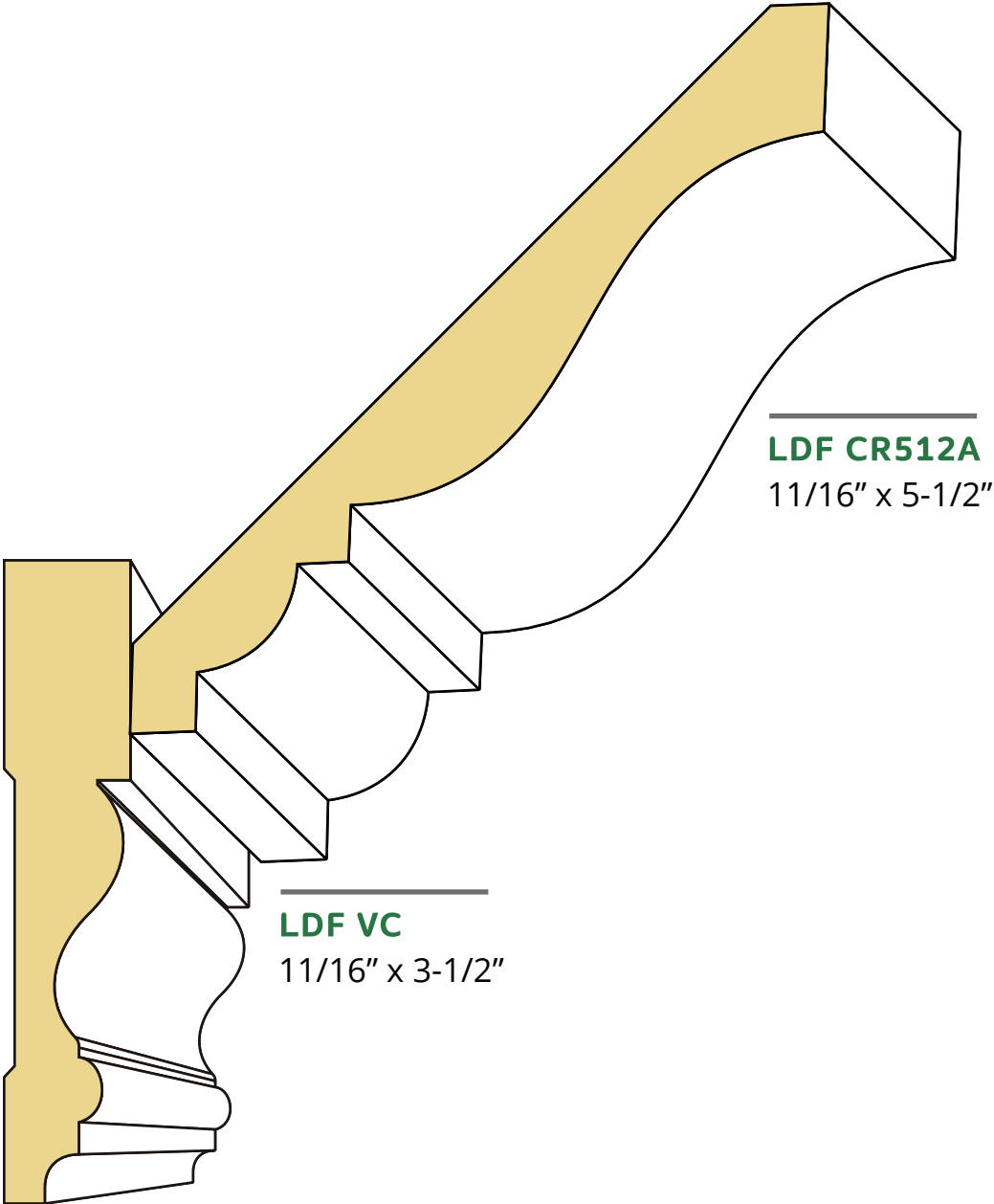

COMBINATIONS

14 LDF

3/4" x 3-1/2"

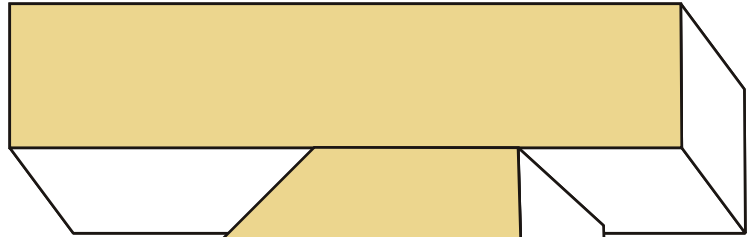

LDF CR7

1-3/16" x 7"

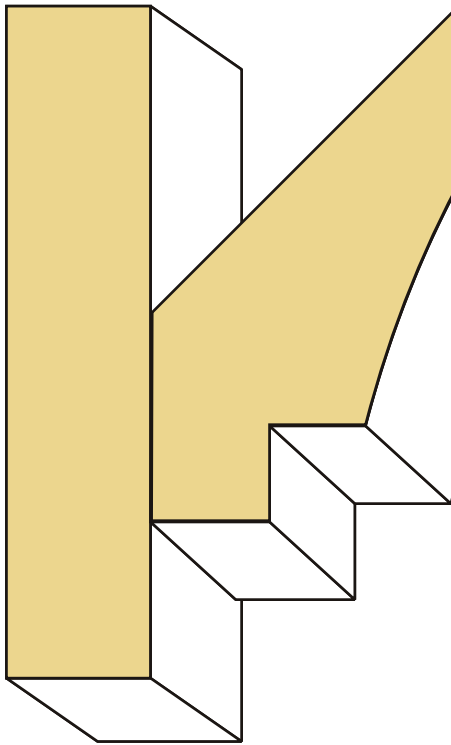

14 LDF

3/4" x 3-1/2"

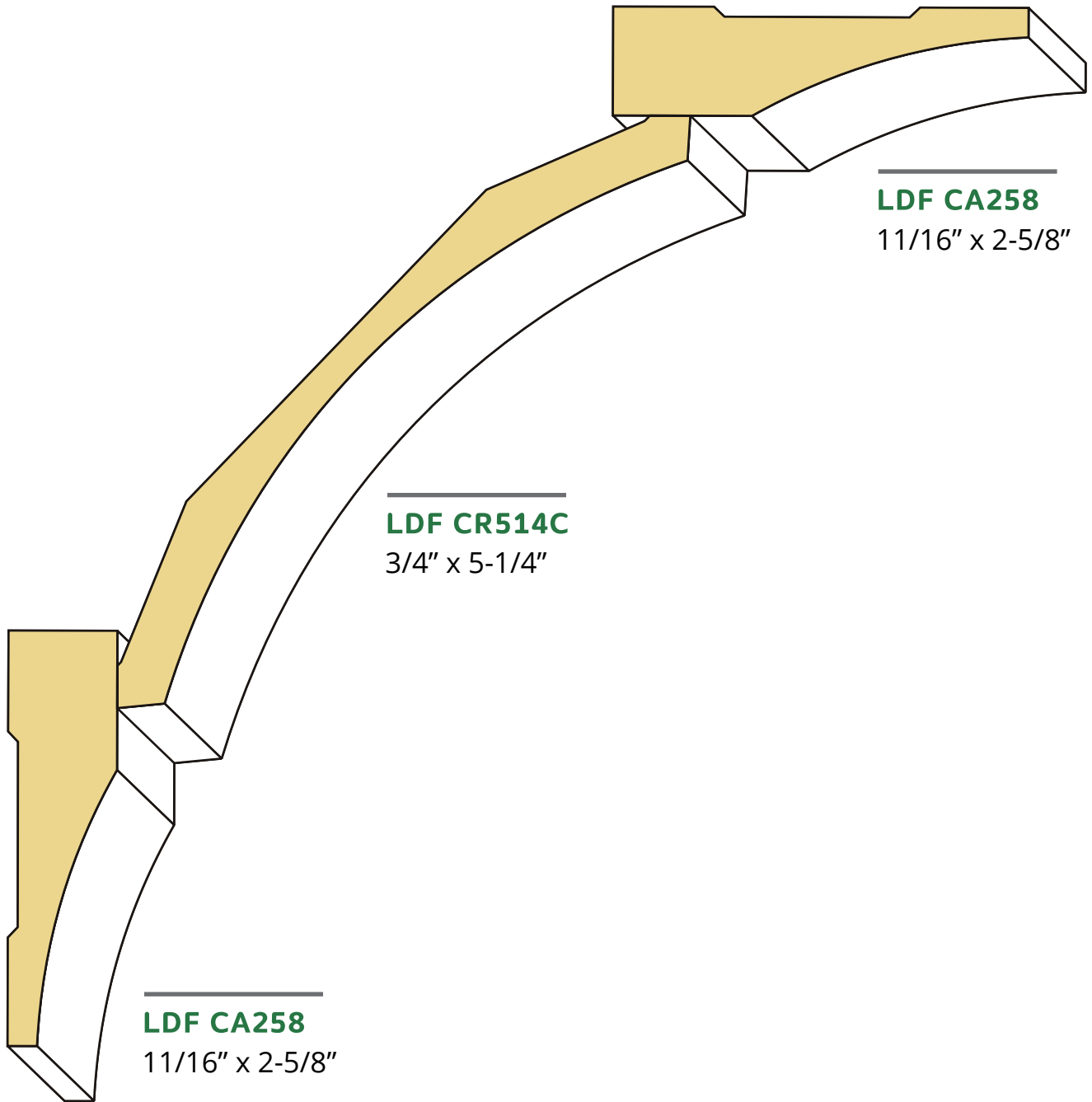

LDF Doors

PLANTATION SERIES

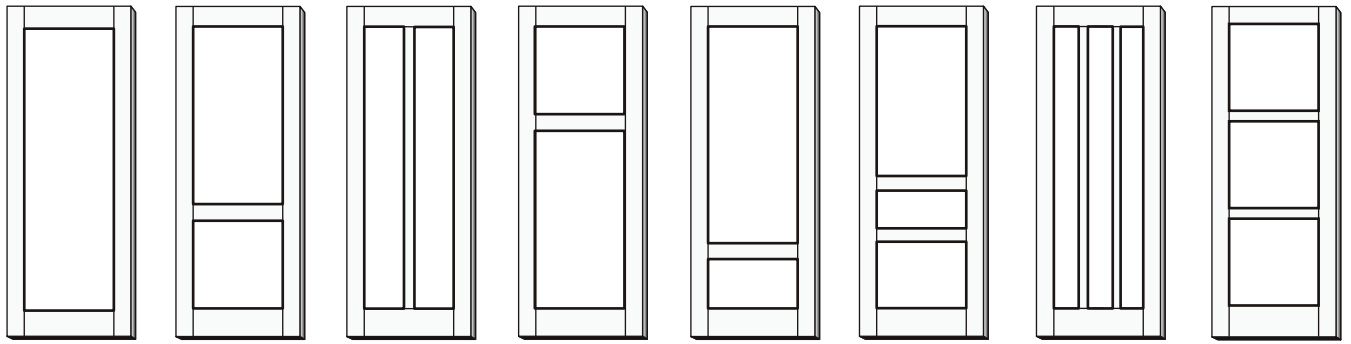

PN 101 PN 201 PN 219 PN 223 PN 224 PN 301 PN 308 PN 310

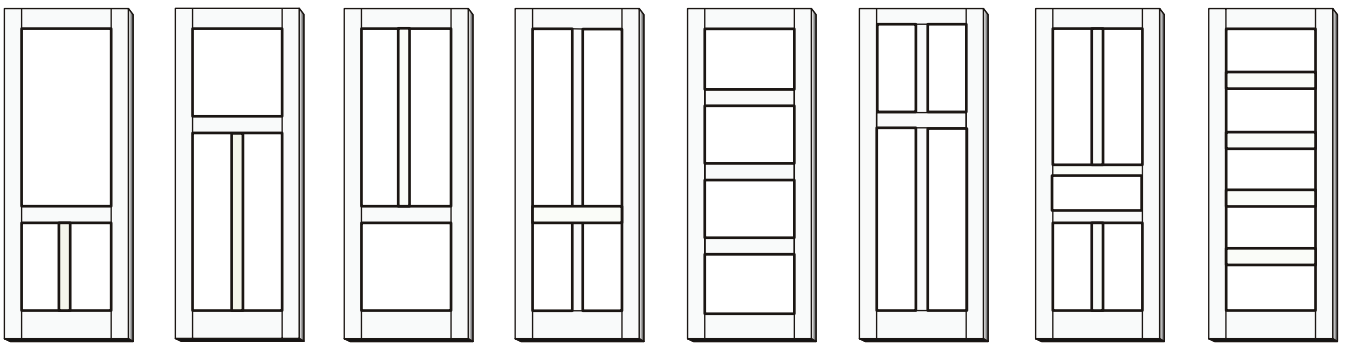

PN 319 PN 324 PN 325 PN 401 PN 410 PN 415 PN 501 PN 510

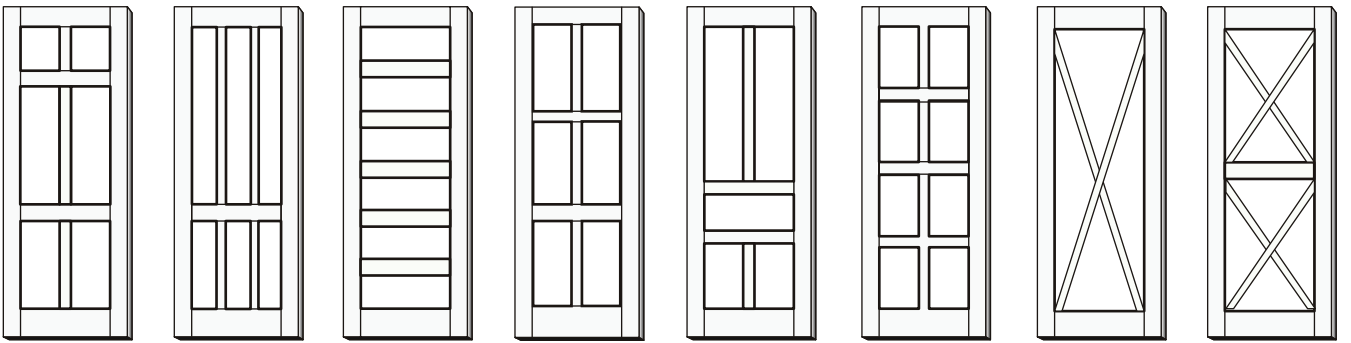

PN 601 PN 607 PN 610 PN 611 PN 701 PN 801 PN 902 PN 904

Step Profile

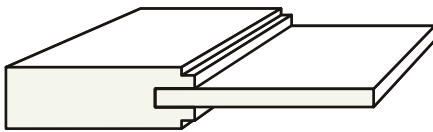

Beveled Profile

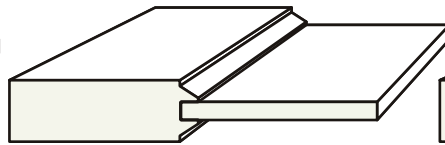

Ogee Profile

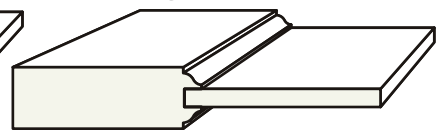

Ovolo Profile

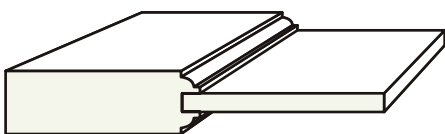

Square Edge Profile

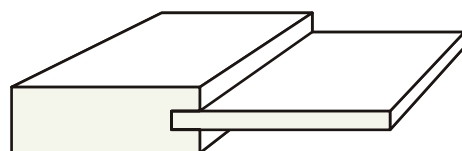

CUSTOM ENTRY DOORS BY SPECIAL ORDER

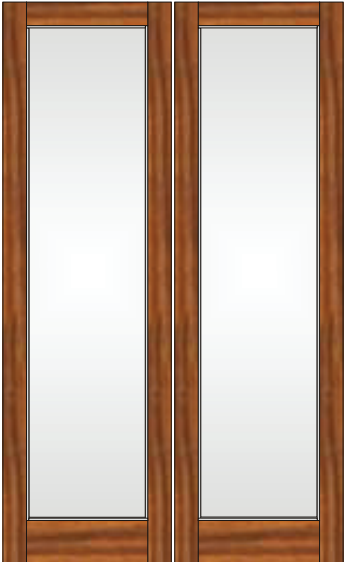
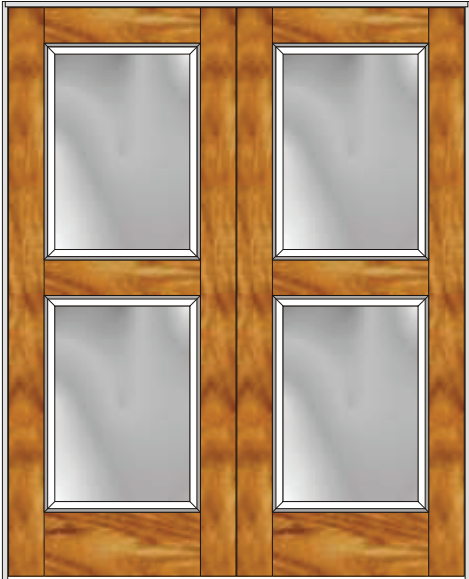

STORAGE AND HANDLING

At no time should Mouldings and Doors to be stored in a damp or freshly plastered area. Store products flat, on a dry interior surface in such a manner as to allow circulation of air. Relative humidity in the area should not be less than 30% or greater than 60%. Never subject Moulding or Doors to abnormal heat, extreme dryness or humidity, or any sudden changes in atmospheric conditions. All Hardwood products should be allowed to acclimate to the average prevailing atmospheric conditions within the installation area.

FINISHING

Due to the nature of the materials and various finishes available, Smith & DeShields makes no claim as to the possible finished product, however, the following recommendations are offered and should be adhered to:

- All Moulding and LDF Doors must be finished with 120 or 150 grit sandpaper prior to finishing.
- Avoid initial sanding with grit finer than 120.
- Always seal all concealed and back surfaces of Moulding to minimize expansion and contraction (expansion and contraction is a natural characteristic of wood products and will not be deemed a defect).
- Always consult the manufacturer of the finish to be used as to its specific application on the species of wood chosen. Various finishes react differently to various woods.

COME VISIT OUR DESIGN CENTERS





VISIT ONE OF OUR SHOWROOM LOCATIONS

📍 NAPLES - FL
2360 TRADE CENTER WAY
34109

☎️ (239) 591-2224

📍 FORT MYERS - FL
11790 METRO PARKWAY, SUITE B
33966

☎️ (239) 337-2224

📍 BOCA RATON - FL
165 N.W. 20TH STREET
33431

☎️ (561) 395-0808

📍 JUPITER - FL
1001 JUPITER PARK DRIVE, SUITE 124
33458

☎️ (561) 427-0808